

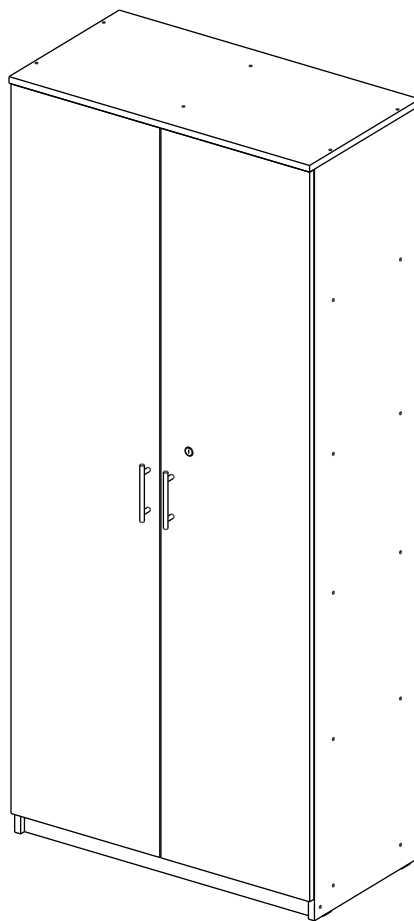

MOBMAN™

www.mobman.ro



Dulap cu lacăt
(Model 10449)

18mm

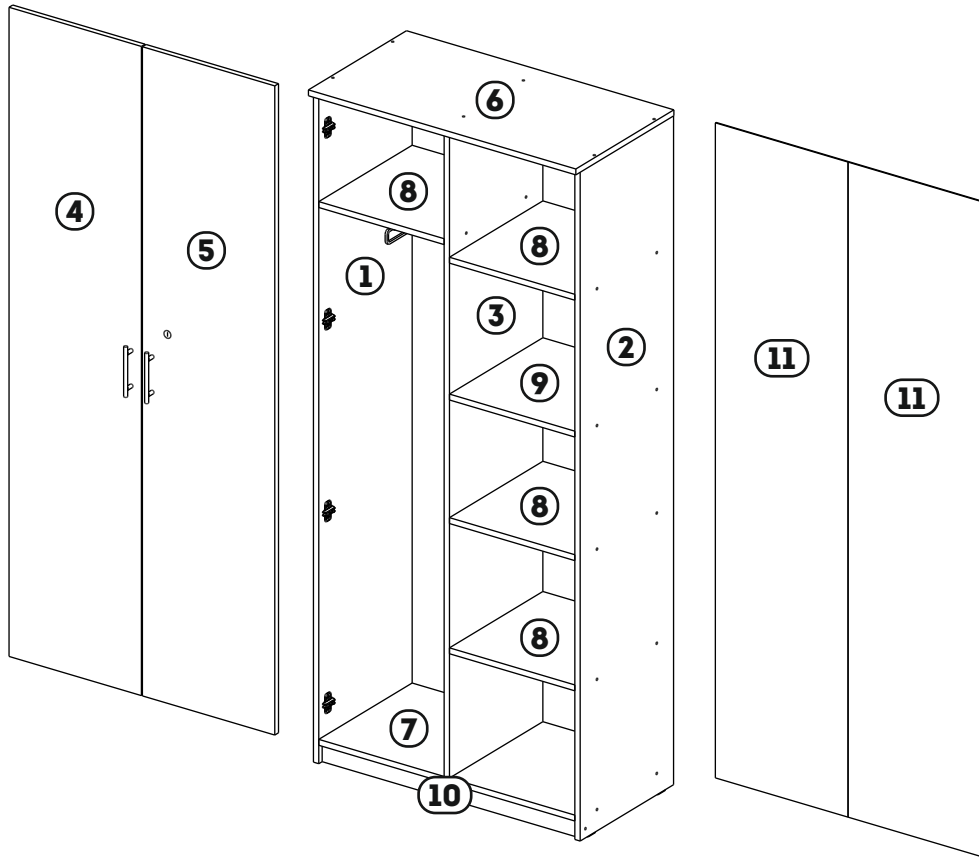

No	a*b	Bucati
1	1882x400	1
2	1882x400	1
3	1828x397	1
4	1828x397	1
5	1814x400	1
6	802x420	1
7	764x400	1
8	373x400	4
9	373x400	1
10	50x764	1
11	1846x397	2

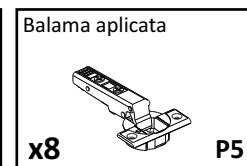
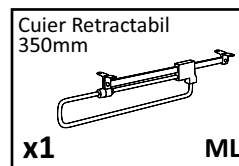
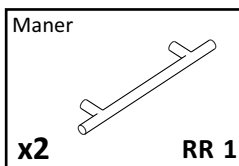
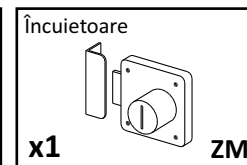
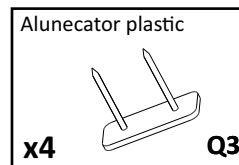
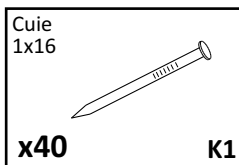
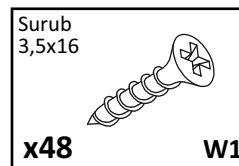
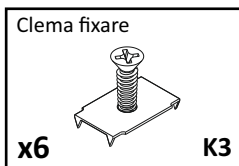
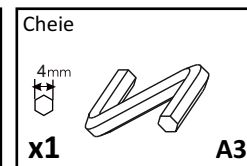
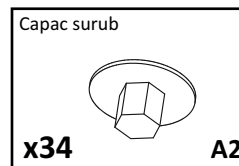
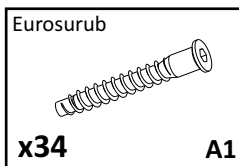

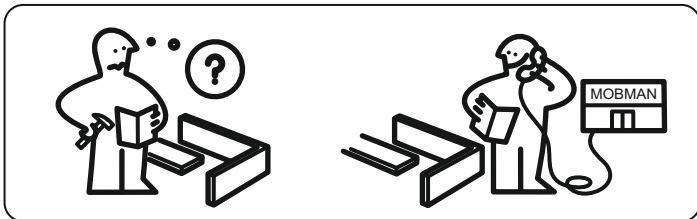
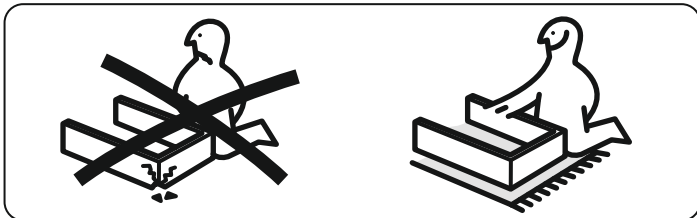
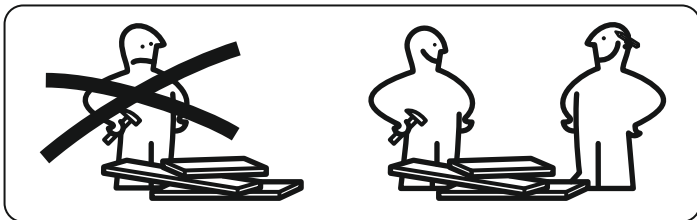

**ASISTENTA: 0371.71.79.79 SAU
OFFICE@MOBMAN.RO**



MOBMAN™

www.mobman.ro

INSTRUCTIUNI TEHNICE GENERALE PENTRU MONTAJ MOBILIER

- VERIFICATI COMPATIBILITATEA PIESELOR SI ACCESORIILOR INAINTE DE MONTAJ.
- PENTRU MONTAJUL MOBILIERULUI, RECOMANDAM FOLOSIREA SERVICIILOR PERSOANELOR CALIFICATE.
- FACETI MONTAJUL PE O SUPRAFATA ACOPERITA CU PANZA SAU CARTON PENTRU A EVITA ZGARIETURILE.

INGRIJIREA SI INTRETINEREA MOBILIERULUI

- EVITATI CONTACTUL PRELUNGIT CU APA SAU CU ABURI.
- PASTRATI O DISTANTA CORESPUNZATOARE FATA DE APARATE ELECTRICE SI INCALZITOARE.
- INDEPARTATI MURDARIA CU O CARPA UMEDA APOI STERGETI. NU UTILIZATI MATERIALE ABRAZIVE.

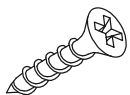
1Surub
3,5x16**x16****W1**

Placa de montare

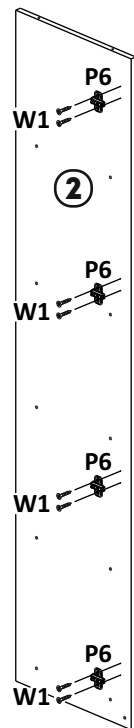
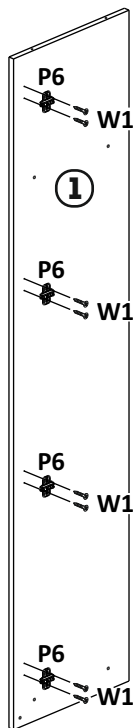
**x8****P6****2**

Eurosurub

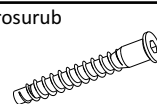
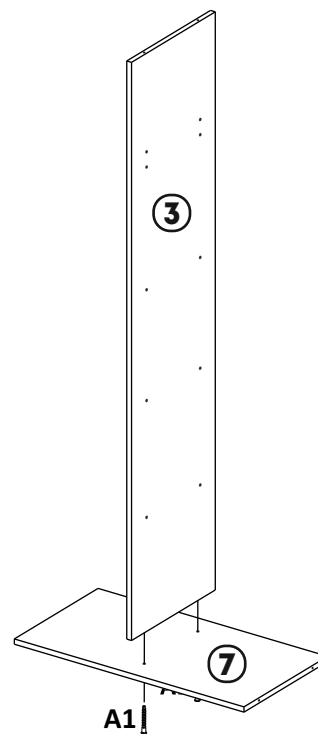
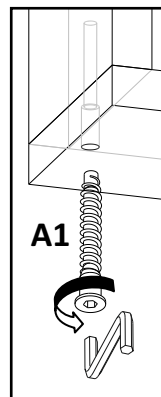
**x2****A1**

3

Eurosurb

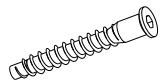

x26

A1

Capac surub



x26

A2

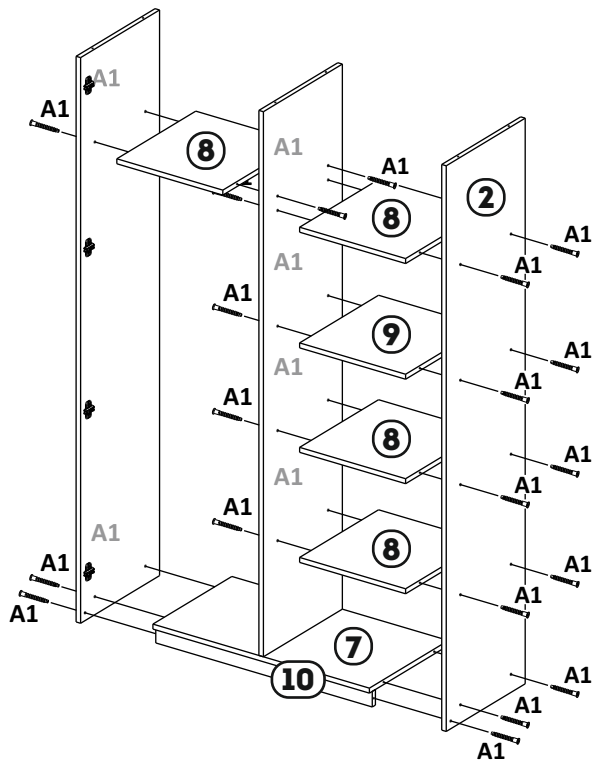
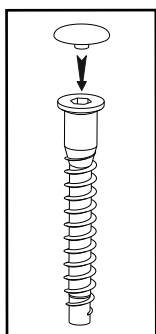
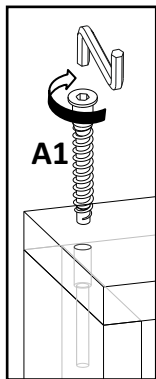
**4**

Eurosurb

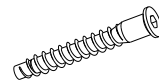

x6

A1

Capac surub

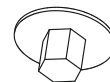

x6

A2

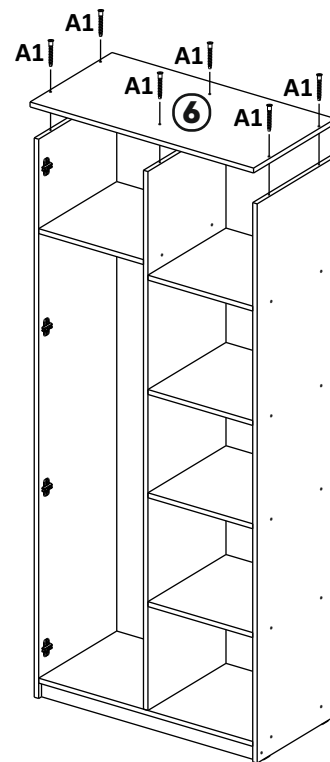

5

Alunecator plastic

x4

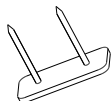

Q3

Clema fixare

x6

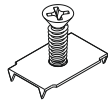

K3

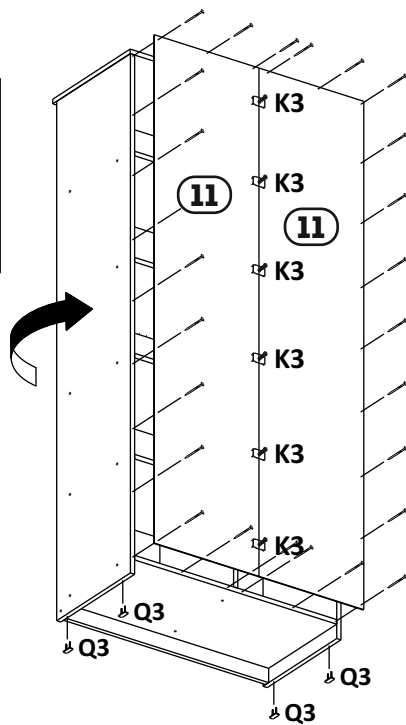
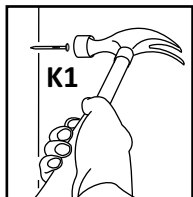
**6**

Balama aplicata

x8



P5

Surub
3,5x16

x16

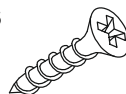

W1

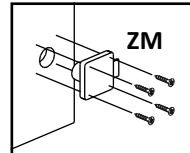

ZM

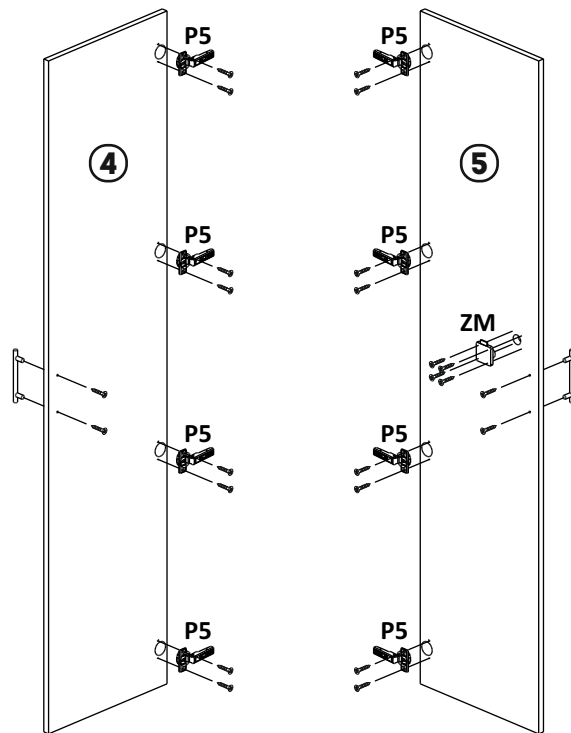
**7**

7

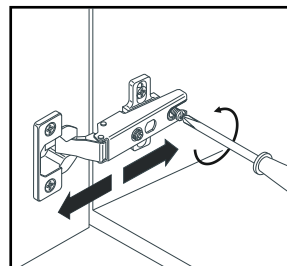
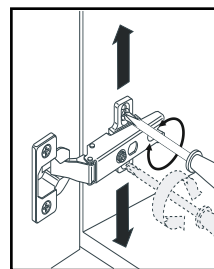
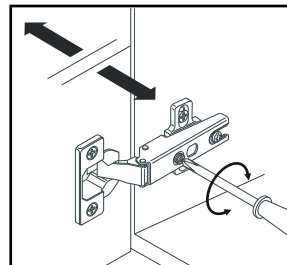
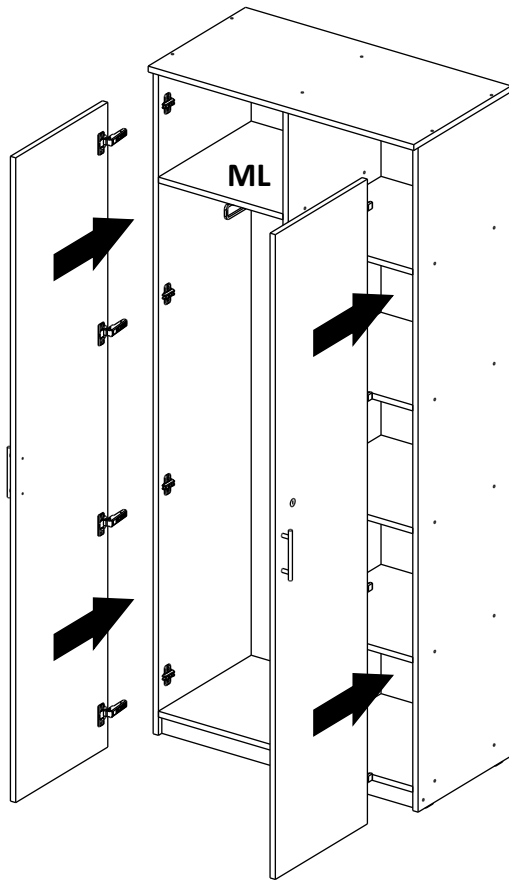
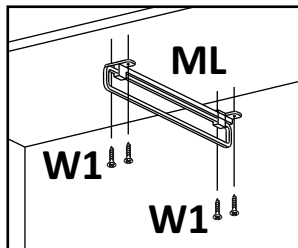

8