

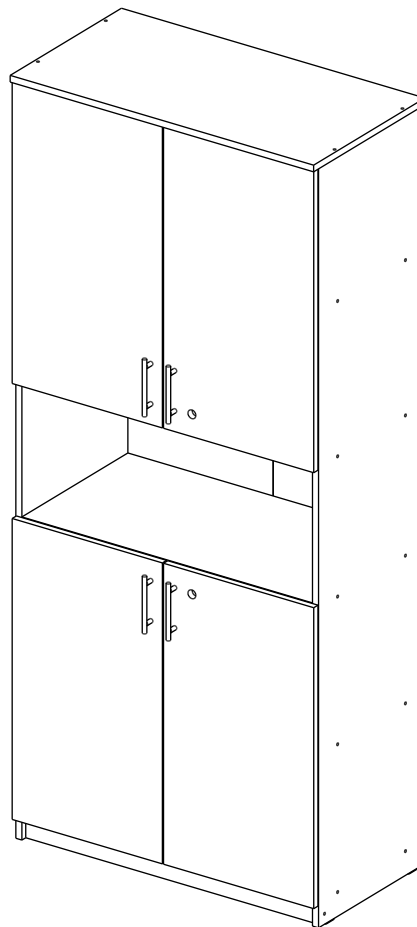

**MOBMAN™**

[www.mobman.ro](http://www.mobman.ro)



Dulap cu lacăt  
(Model 231070)

18mm

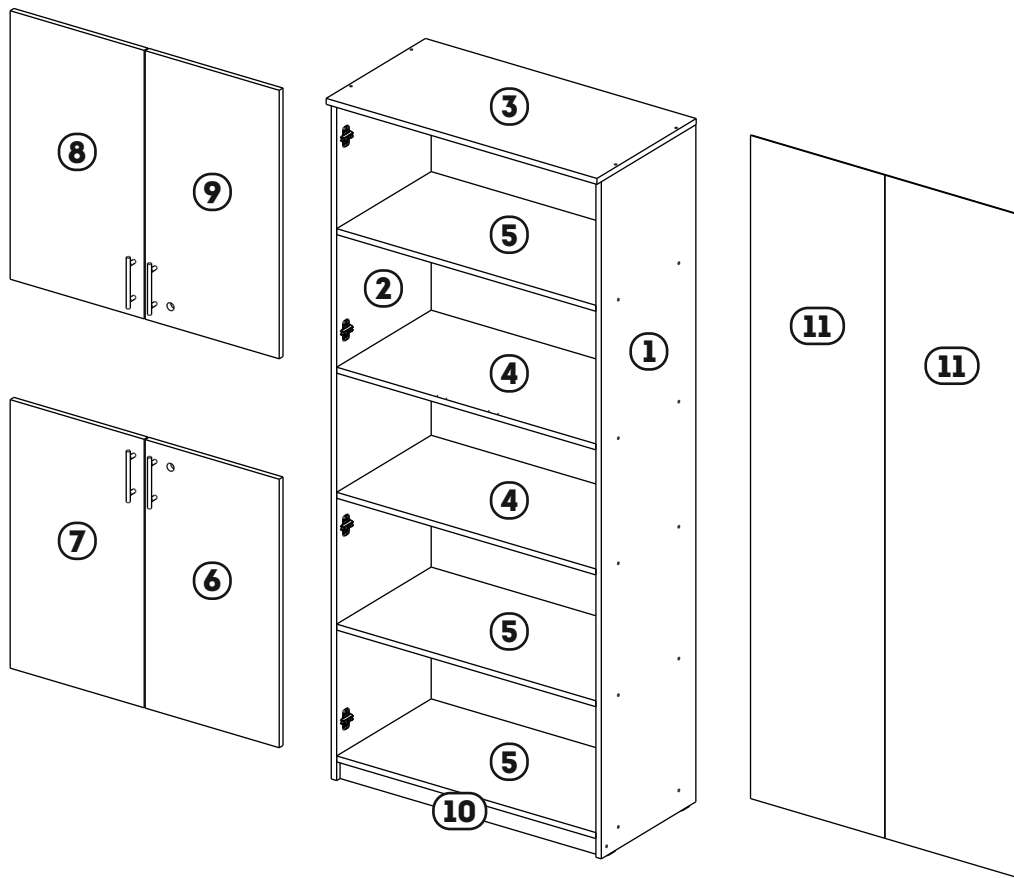

No	a*b	Bucati
1	1882x400	1
2	1882x400	1
3	802x420	1
4	764x400	2
5	764x400	3
6	747x397	1
7	747x397	1
8	747x397	1
9	747x397	1
10	50x764	1
11	1846x398	2

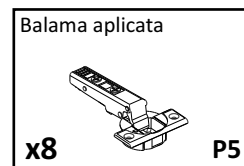
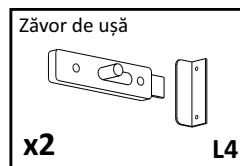
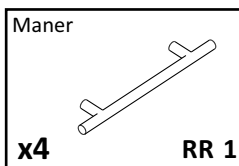
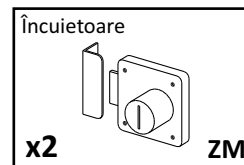
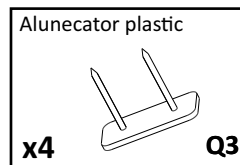
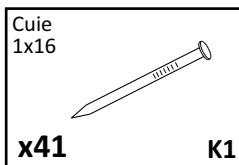
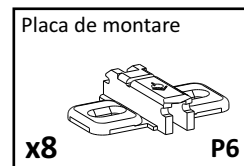
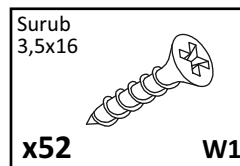
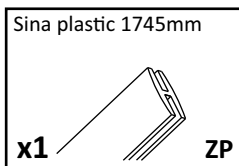
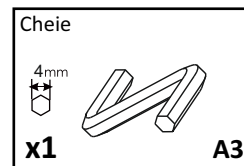
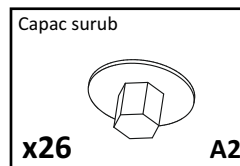
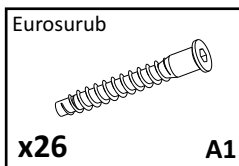

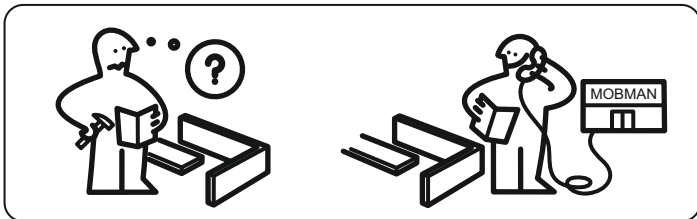
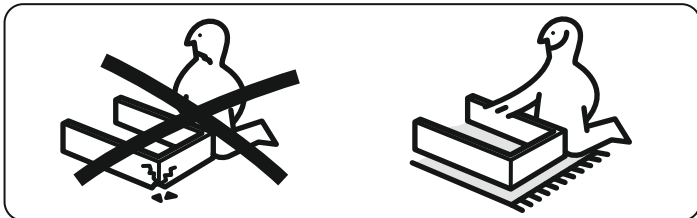
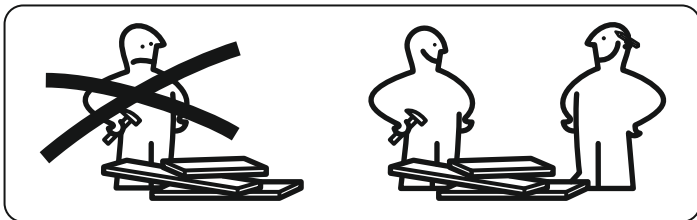

**ASISTENTA: 0371.71.79.79 SAU  
OFFICE@MOBMAN.RO**



**MOBMAN™**

www.mobman.ro

## **INSTRUCTIUNI TEHNICE GENERALE PENTRU MONTAJ MOBILIER**

- VERIFICATI COMPATIBILITATEA PIESELOR SI ACCESORIILOR INAINTE DE MONTAJ.
- PENTRU MONTAJUL MOBILIERULUI, RECOMANDAM FOLOSIREA SERVICIILOR PERSOANELOR CALIFICATE.
- FACETI MONTAJUL PE O SUPRAFATA ACOPERITA CU PANZA SAU CARTON PENTRU A EVITA ZGARIETURILE.

## **INGRIJIREA SI INTRETINEREA MOBILIERULUI**

- EVITATI CONTACTUL PRELUNGIT CU APA SAU CU ABURI.
- PASTRATI O DISTANTA CORESPUNZATOARE FATA DE APARATE ELECTRICE SI INCALZITOARE.
- INDEPARTATI MURDARIA CU O CARPA UMEDA APOI STERGETI. NU UTILIZATI MATERIALE ABRAZIVE.

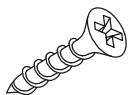
**1**Surub  
3,5x16**x16****W1**

Placa de montare

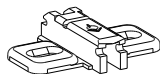
**x8****P6****2**

Încuietoare

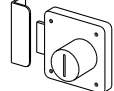
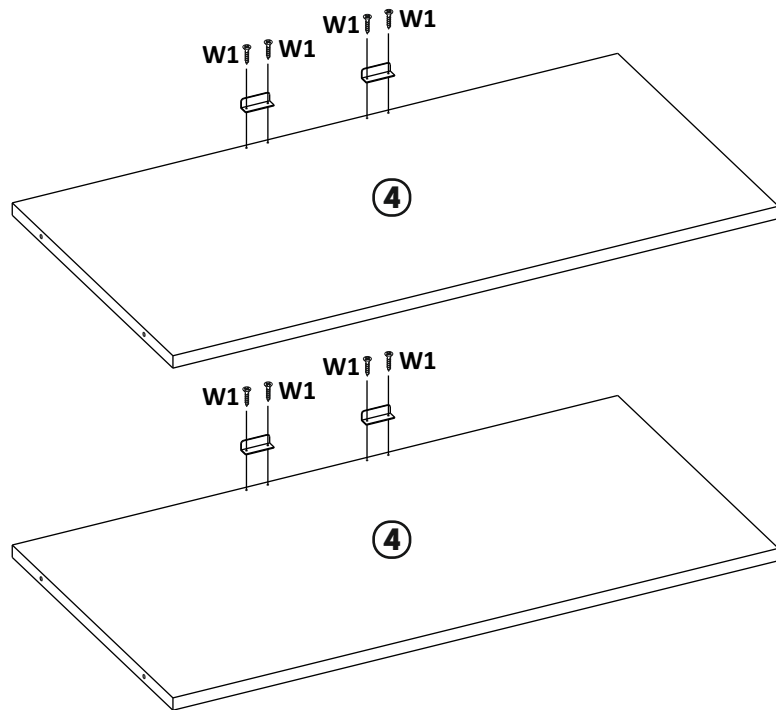
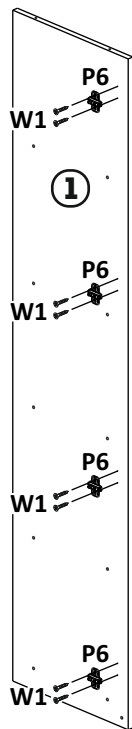
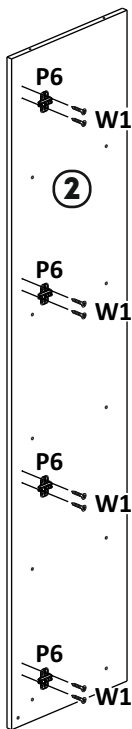
**x2****ZM**

**3**

Eurosurb

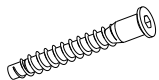

x22

A1

Capac surub



x22

A2

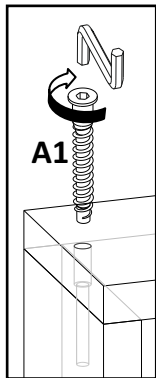

A1

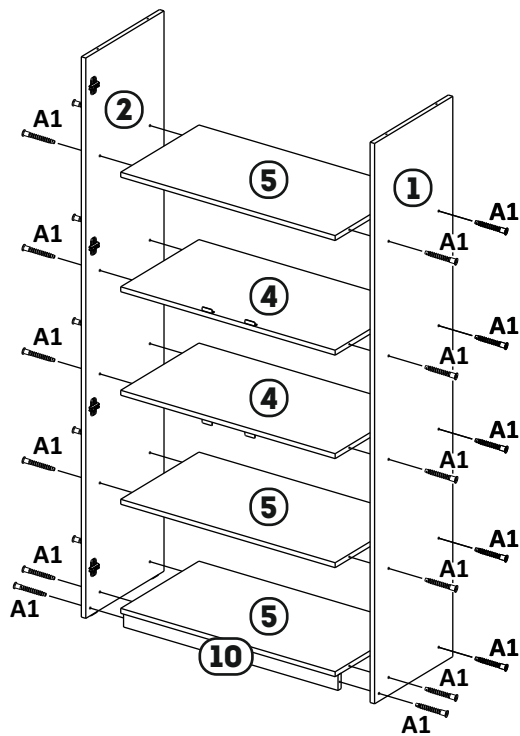
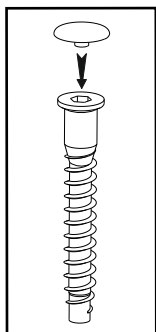
**4**

Alunecator plastic

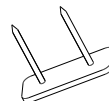

x4

Q3

Eurosurb

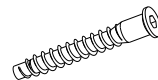

x4

A1

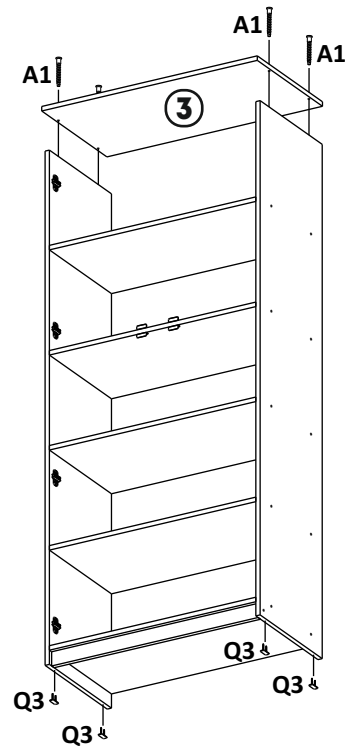

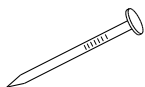
**5**Cuie  
1x16**x41****K1**

Sina plastic 1745mm

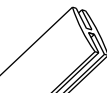
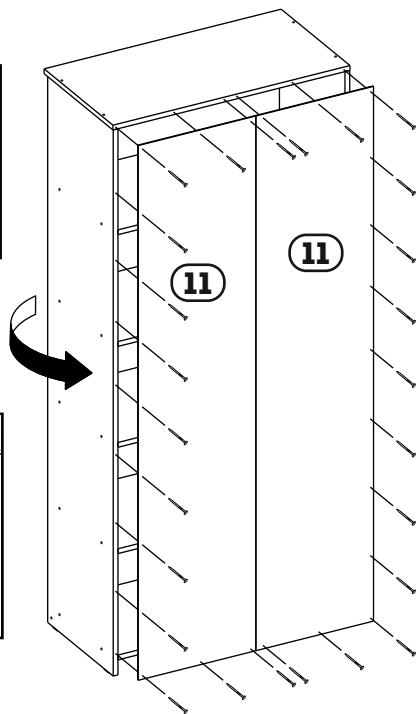
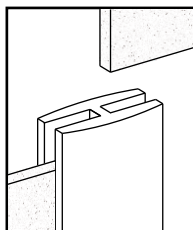
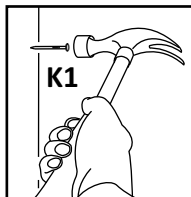
**x1****ZP****6**

Balama aplicata

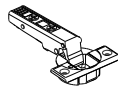
**x8****P5**

Zăvor de ușă

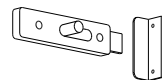
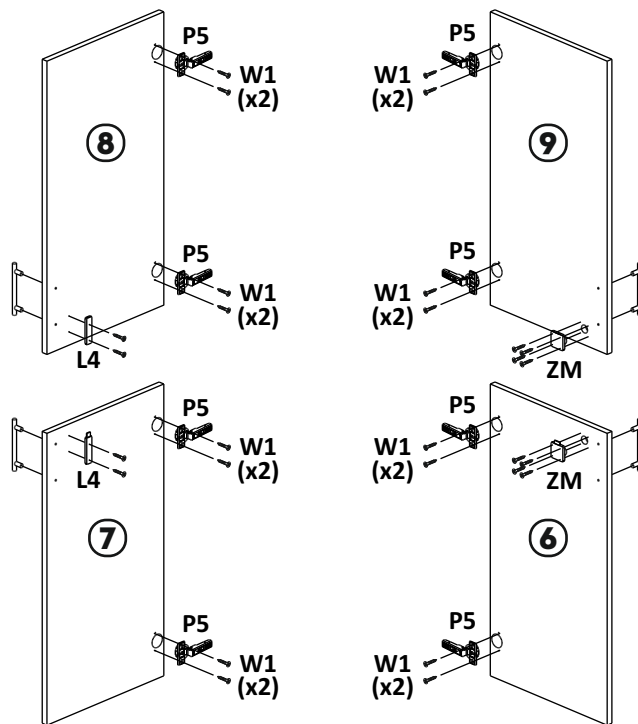
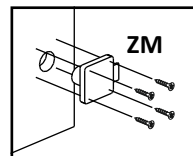
**x2****L4****7**

7

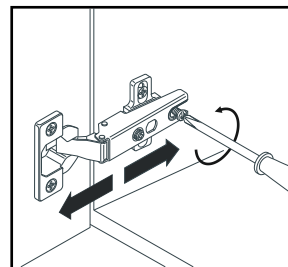
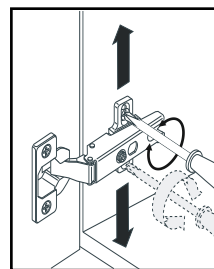
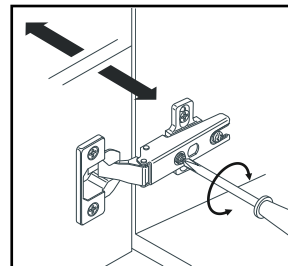
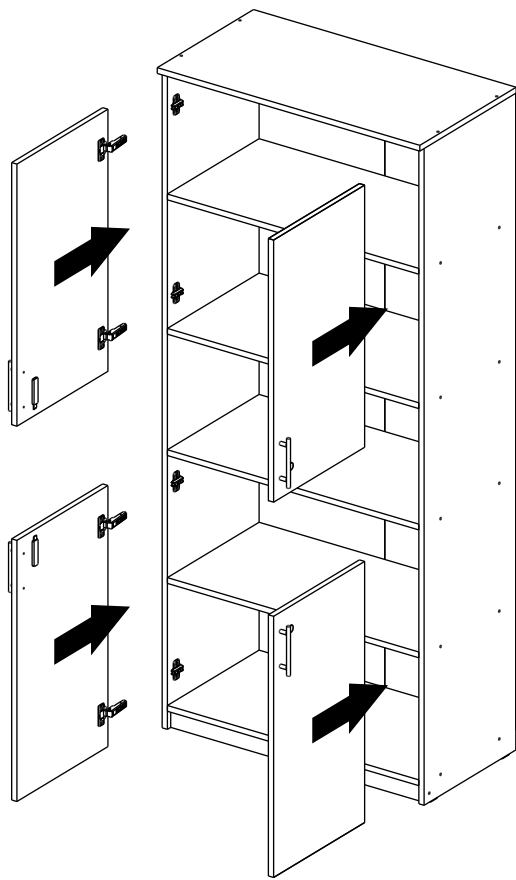

8