

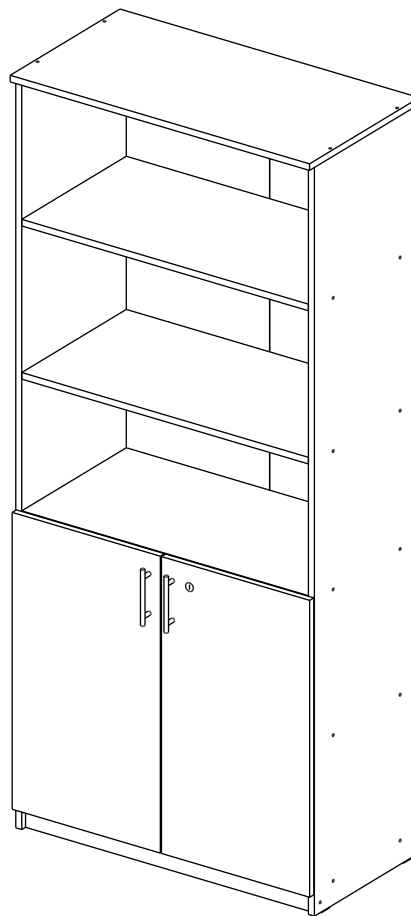

MOBMAN™

www.mobman.ro



Dulap cu lacăt
(Model 231071)

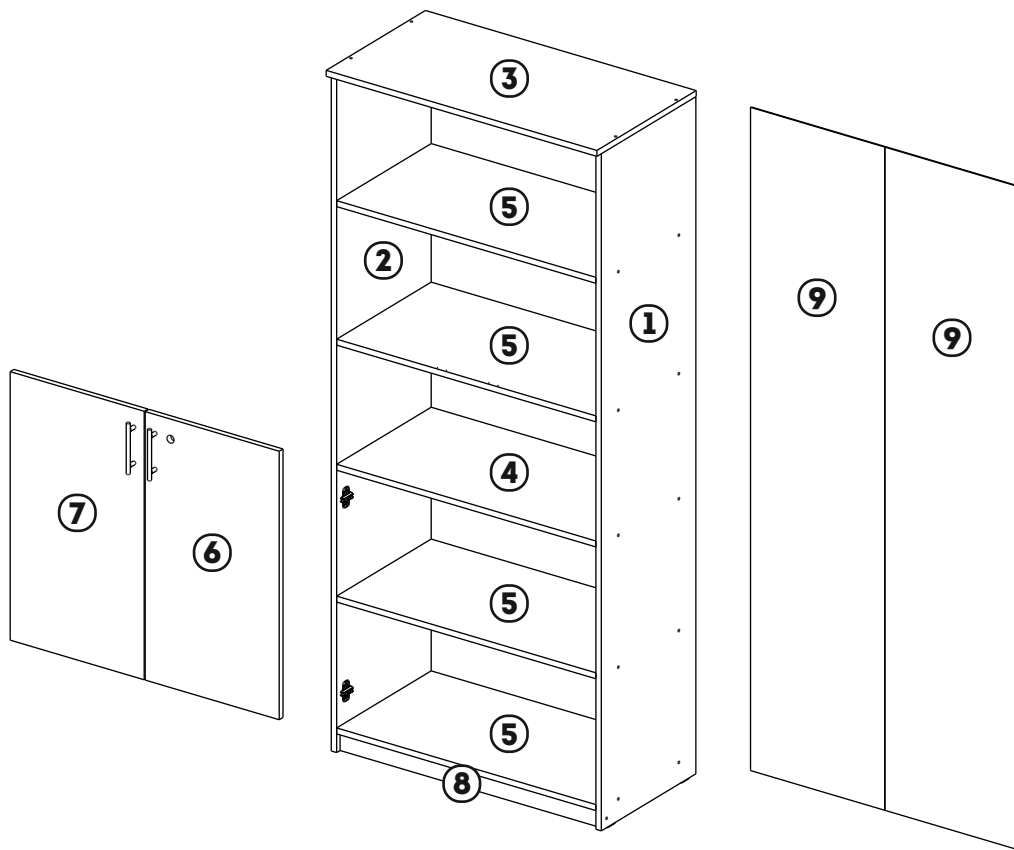

No	a*b	Bucati
1	1882x400	1
2	1882x400	1
3	802x420	1
4	764x400	1
5	764x400	4
6	747x397	1
7	747x397	1
8	50x764	1
9	1846x398	2

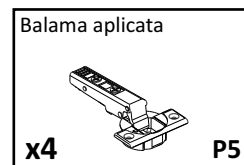
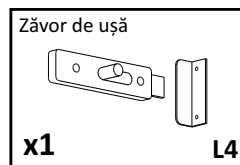
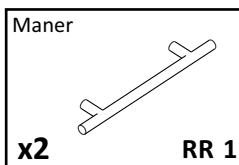
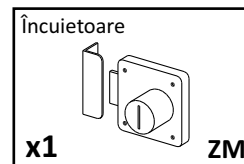
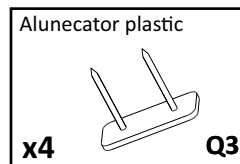
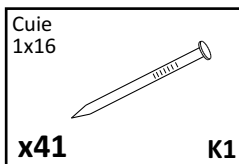
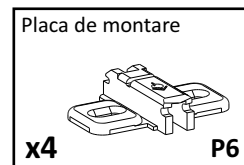
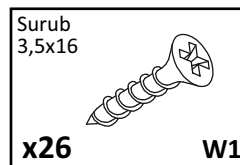
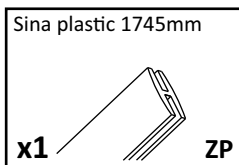
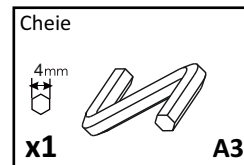
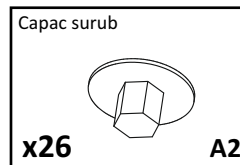
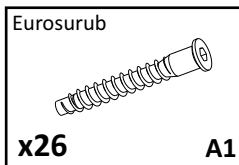

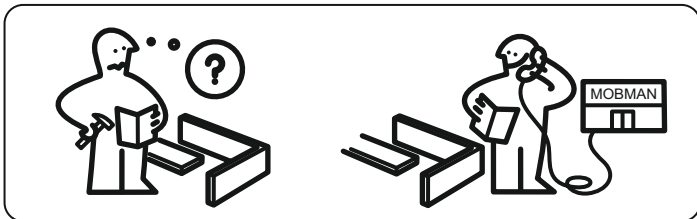
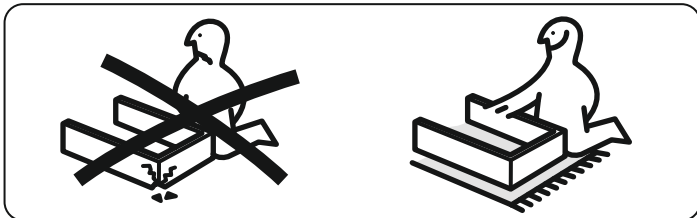
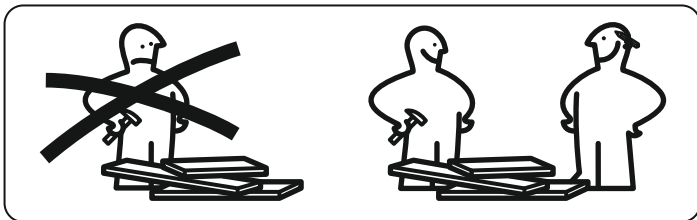

**ASISTENTA: 0371.71.79.79 SAU
OFFICE@MOBMAN.RO**



MOBMAN™

www.mobman.ro

INSTRUCTIUNI TEHNICE GENERALE PENTRU MONTAJ MOBILIER

- VERIFICATI COMPATIBILITATEA PIESELOR SI ACCESORIILOR INAINTE DE MONTAJ.
- PENTRU MONTAJUL MOBILIERULUI, RECOMANDAM FOLOSIREA SERVICIILOR PERSOANELOR CALIFICATE.
- FACETI MONTAJUL PE O SUPRAFATA ACOPERITA CU PANZA SAU CARTON PENTRU A EVITA ZGARIETURILE.

INGRIJIREA SI INTRETINEREA MOBILIERULUI

- EVITATI CONTACTUL PRELUNGIT CU APA SAU CU ABURI.
- PASTRATI O DISTANTA CORESPUNZATOARE FATA DE APARATE ELECTRICE SI INCALZITOARE.
- INDEPARTATI MURDARIA CU O CARPA UMEDA APOI STERGETI. NU UTILIZATI MATERIALE ABRAZIVE.

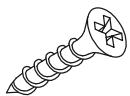
1Surub
3,5x16**x16****W1**

Placa de montare

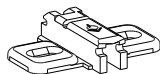
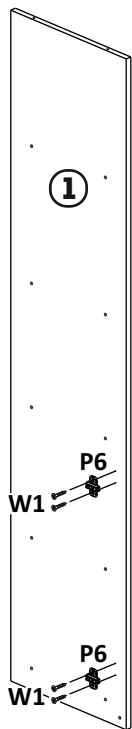
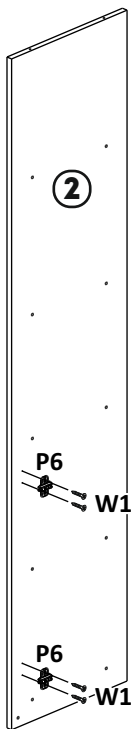
**x8****P6****2**

Încuietoare

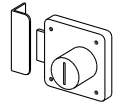
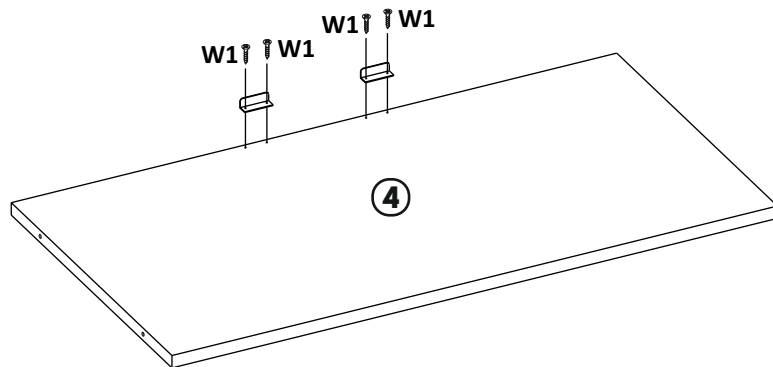
**x1****ZM**

3

Eurosurub

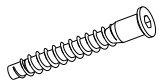

x22

A1

Capac surub



x22

A2

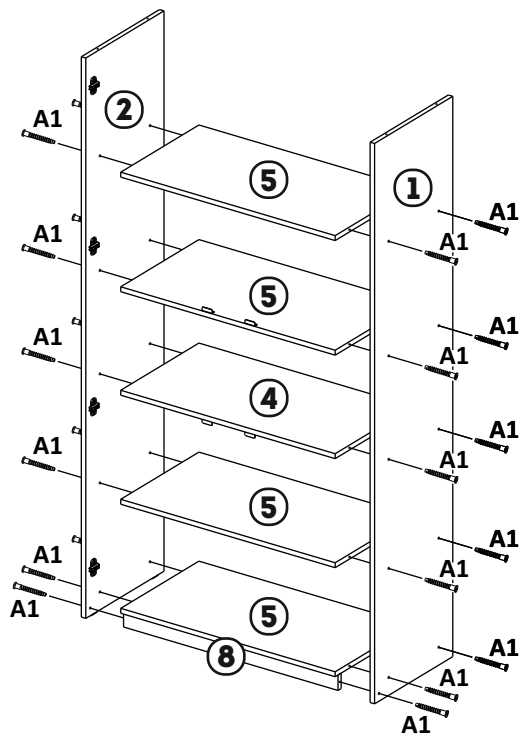
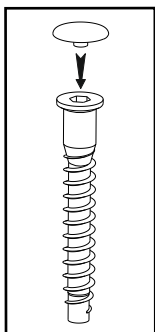
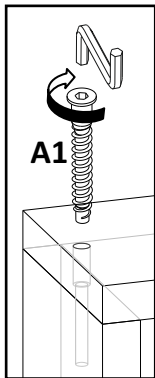

4

Alunecator plastic

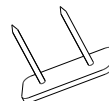

x4

Q3

Eurosurub

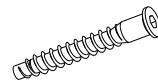

x4

A1

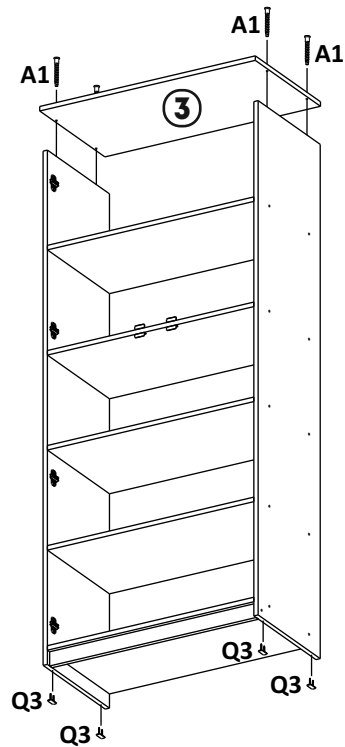

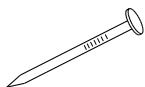
5Cuie
1x16**x41****K1**

Sina plastic 1745mm

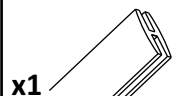
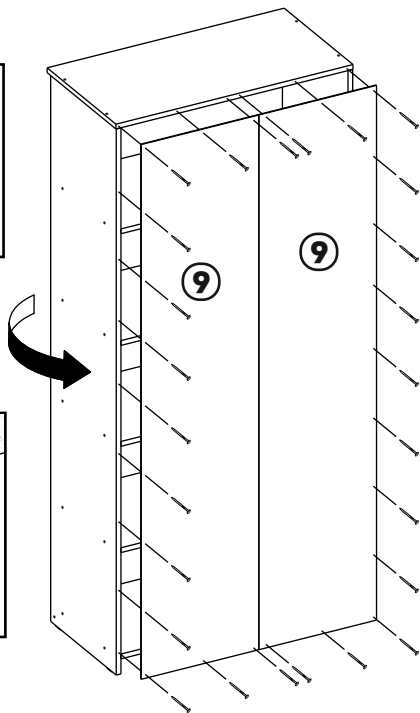
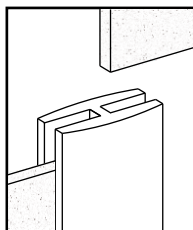
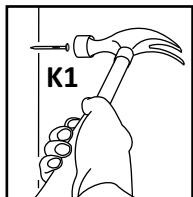
**x1****ZP****6**

Balama aplicata

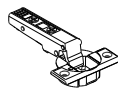
**x4****P5**

Zăvor de uşă

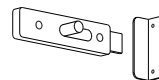
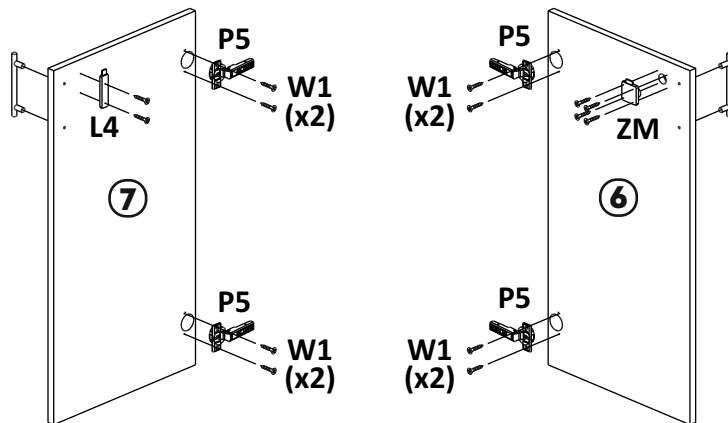
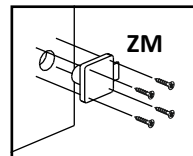
**x1****L4****7**

7

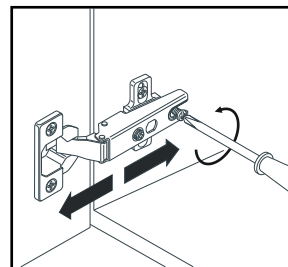
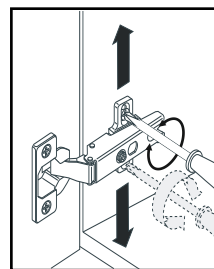
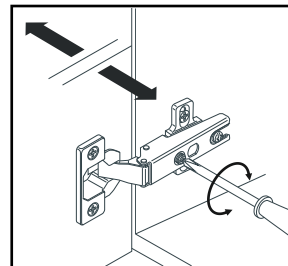
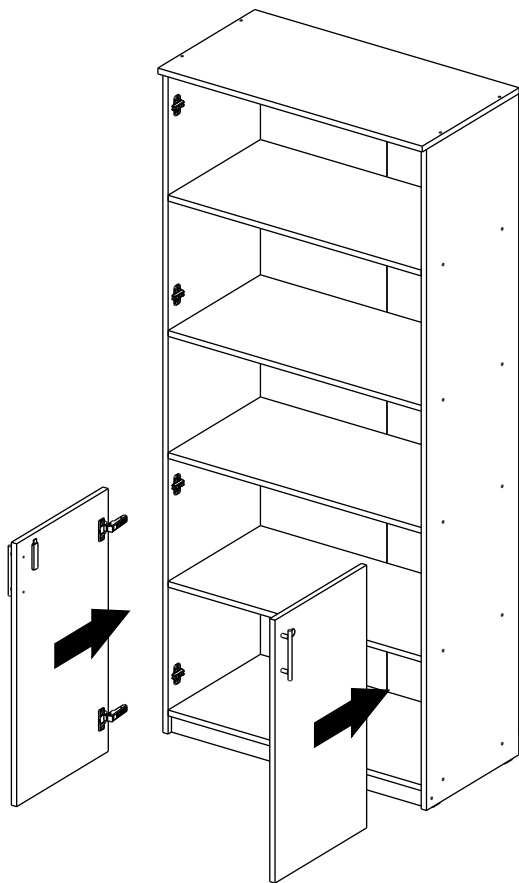

8