

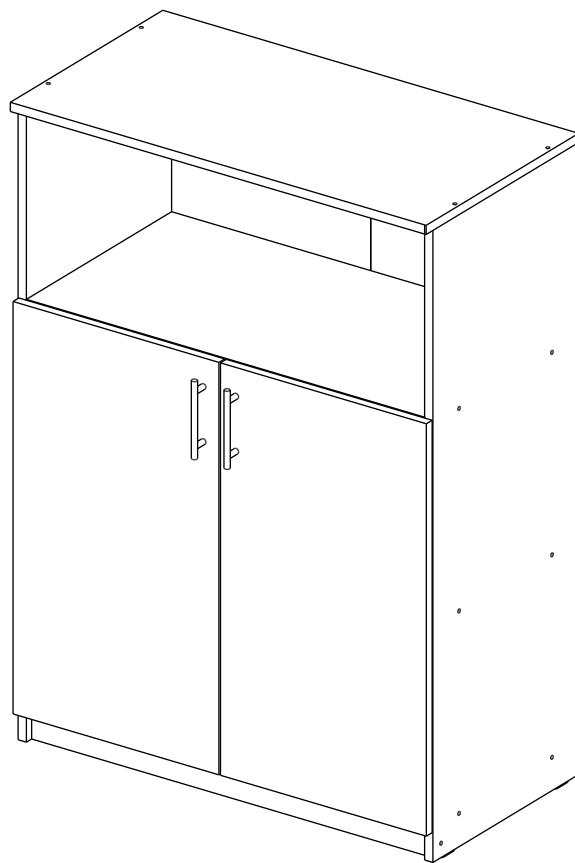

MOBMAN™

www.mobman.ro



Noptiera
(Model 231083)

18mm

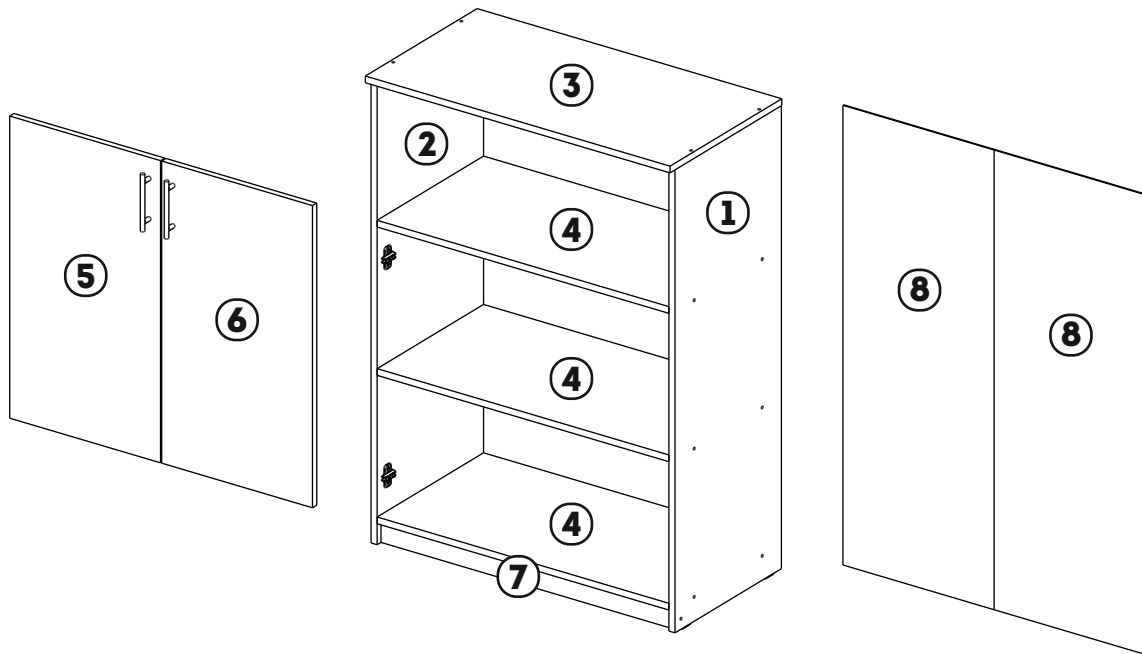

No	a*b	Bucati
1	1082x400	1
2	1082x400	1
3	802x420	1
4	764x400	3
5	721x397	1
6	721x397	1
7	764x49	1
8	1047x398	2

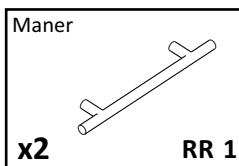
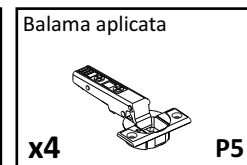
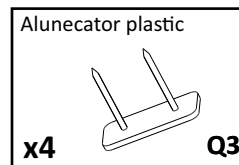
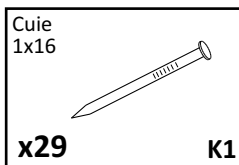
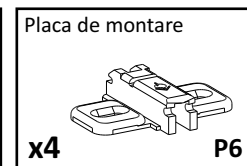
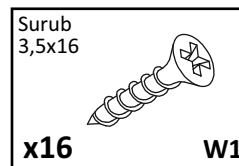
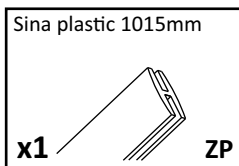
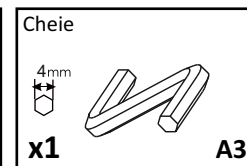
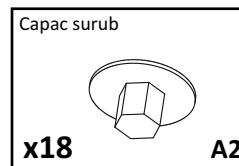
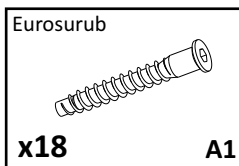

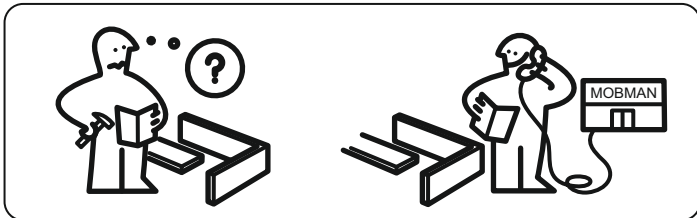
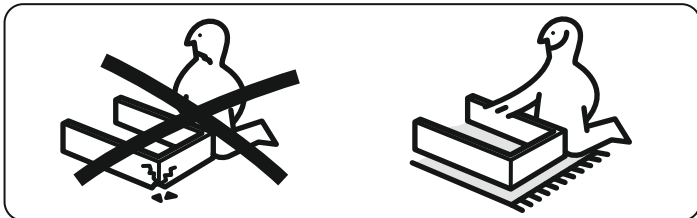
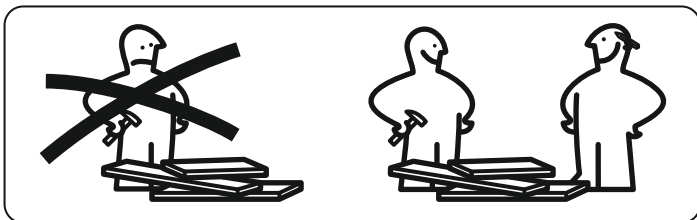

**ASISTENTA: 0371.71.79.79 SAU
OFFICE@MOBMAN.RO**



MOBMAN™

www.mobman.ro

INSTRUCTIUNI TEHNICE GENERALE PENTRU MONTAJ MOBILIER

- VERIFICATI COMPATIBILITATEA PIESELOR SI ACCESORIILOR INAINTE DE MONTAJ.
- PENTRU MONTAJUL MOBILIERULUI, RECOMANDAM FOLOSIREA SERVICIILOR PERSOANELOR CALIFICATE.
- FACETI MONTAJUL PE O SUPRAFATA ACOPERITA CU PANZA SAU CARTON PENTRU A EVITA ZGARIETURILE.

INGRIJIREA SI INTRETINEREA MOBILIERULUI

- EVITATI CONTACTUL PRELUNGIT CU APA SAU CU ABURI.
- PASTRATI O DISTANTA CORESPUNZATOARE FATA DE APARATE ELECTRICE SI INCALZITOARE.
- INDEPARTATI MURDARIA CU O CARPA UMEDA APOI STERGETI. NU UTILIZATI MATERIALE ABRAZIVE.

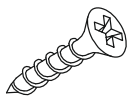
1Surub
3,5x16

x16

W1

Placa de montare

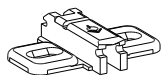

x8

P6

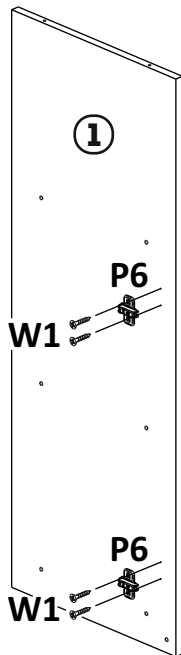
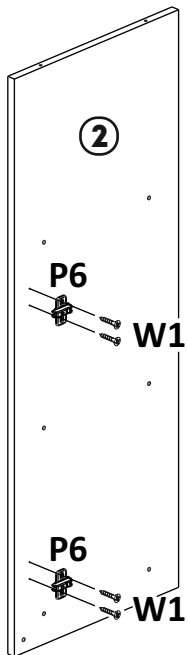
**2**

Eurosurub

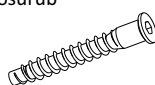

x22

A1

Capac surub

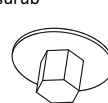

x22

A2

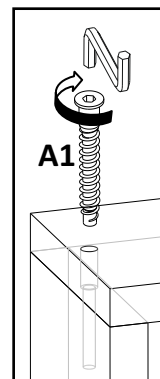
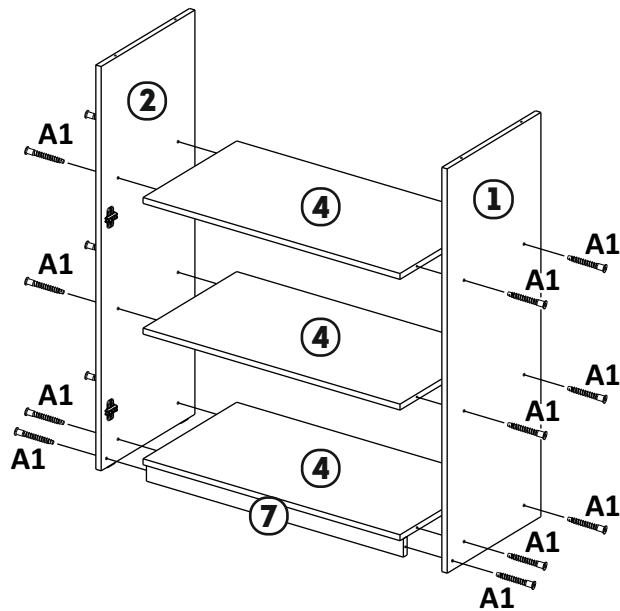

A1

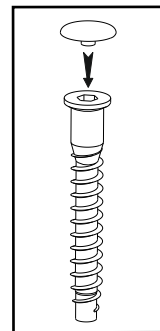

3

Alunecator plastic

x4

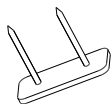

Q3

Eurosurub

x4

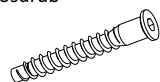

A1

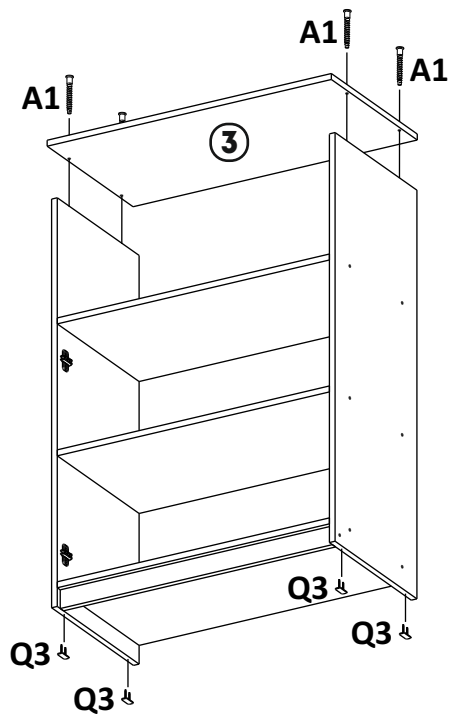
**4**Cuie
1x16

x29

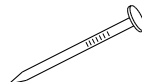

K1

Sina plastic 1015mm

x1



ZP

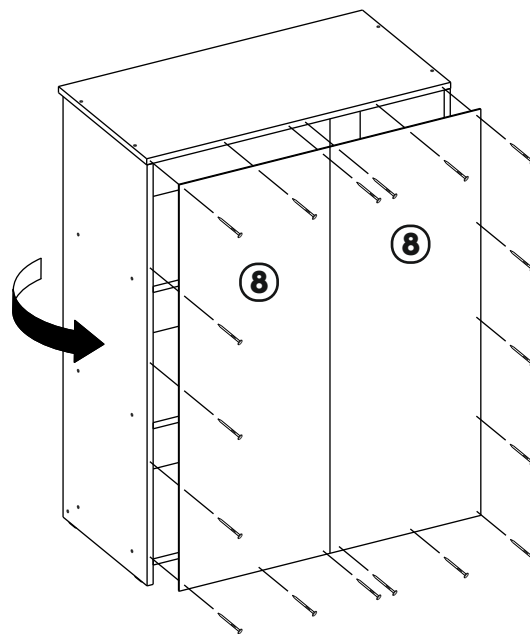
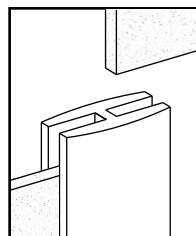
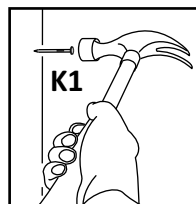

5

Balama aplicata

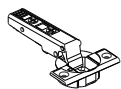
**x4****P5**

Maner

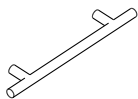
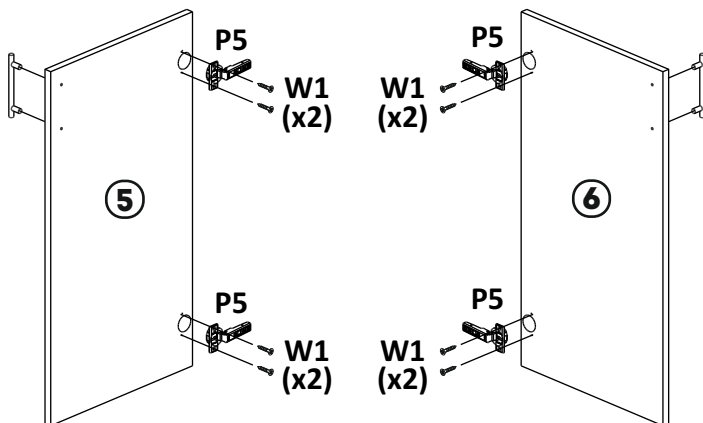
**x2****RR 1****6**