

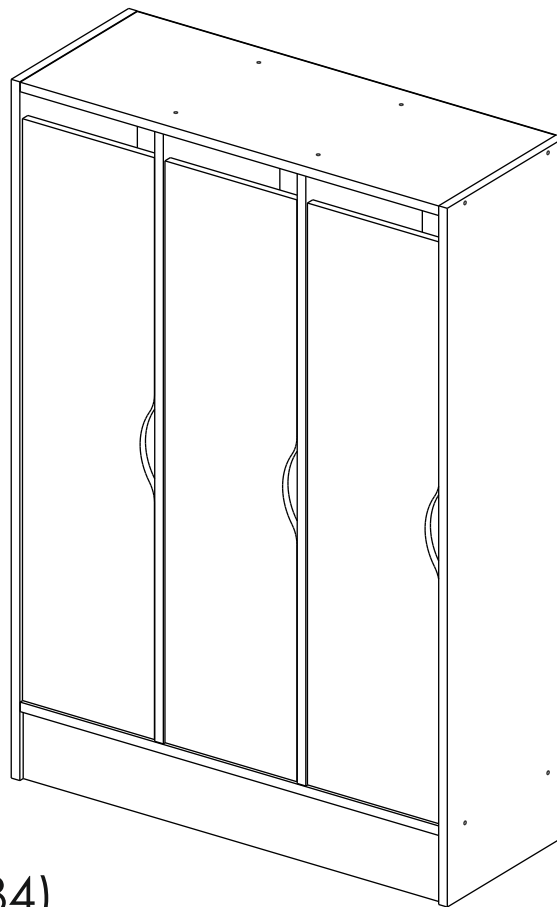

MOBMAN™

www.mobman.ro



Corpus for Oliver 3 doors
(Model 11332 / 11365 / 11334)

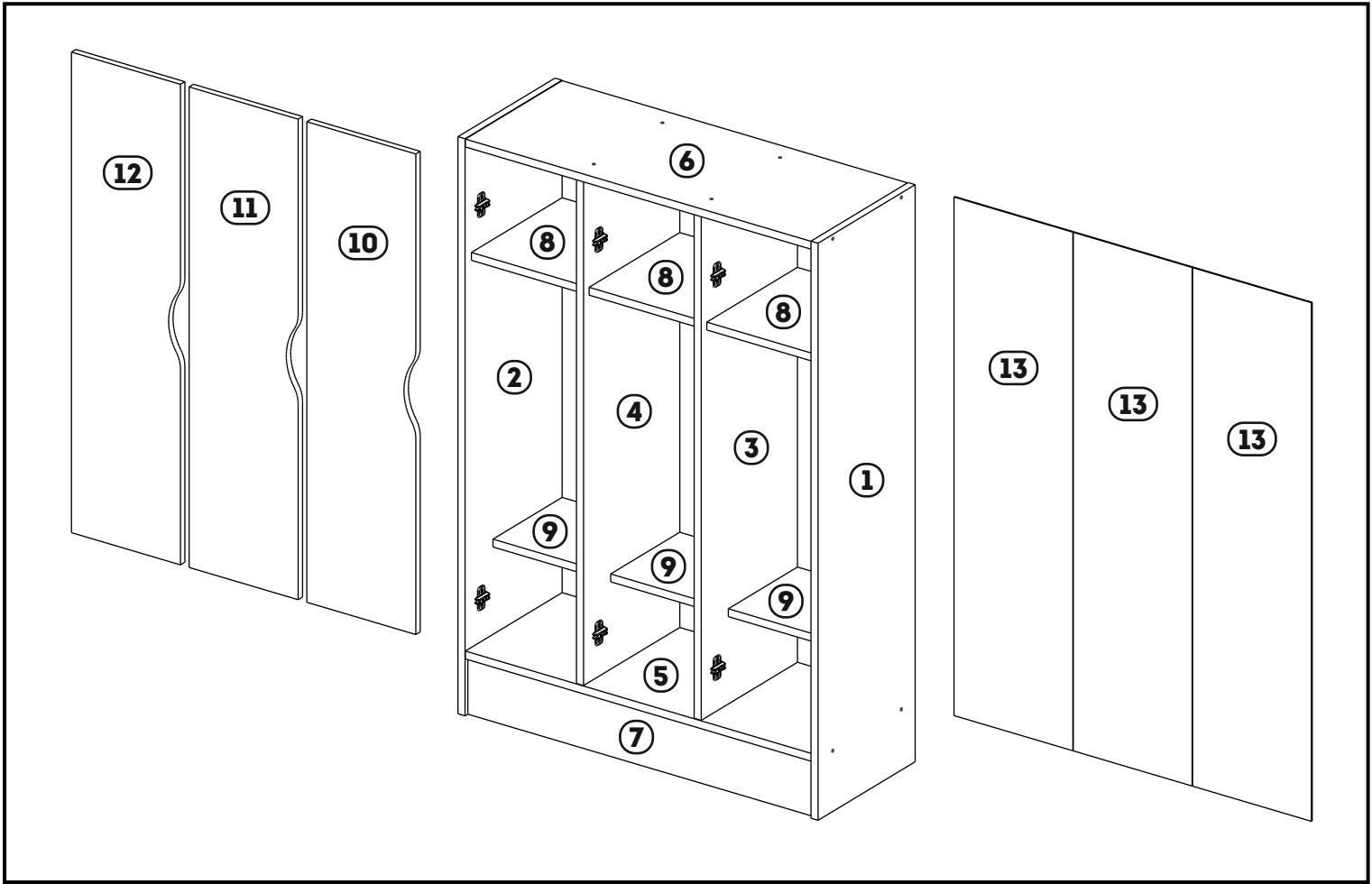

No	a*b	X
1	1321x351	1
2	1321x351	1
3	1154x348	1
4	1154x348	1
5	876x350	1
6	876x350	1
7	876x130	1
8	280x328	3
9	280x250	3
10	1100x276	1
11	1100x276	1
12	1100x276	1
13	1187x301	3

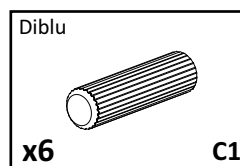
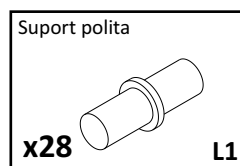
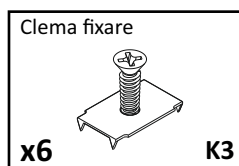
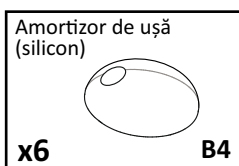
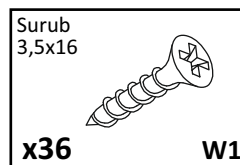
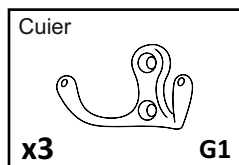
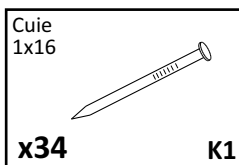
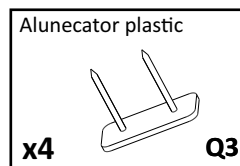
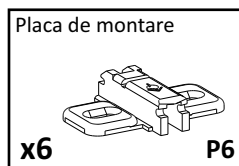
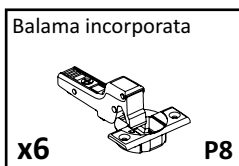
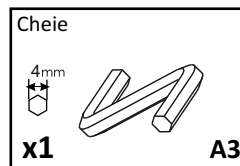
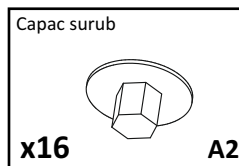
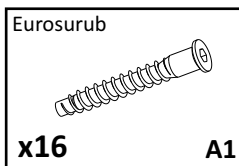

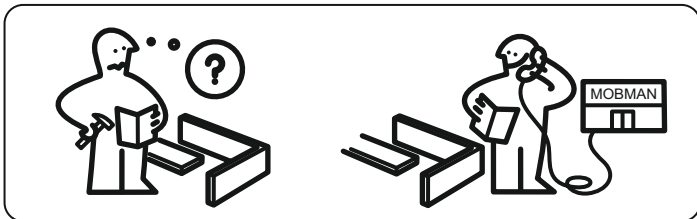
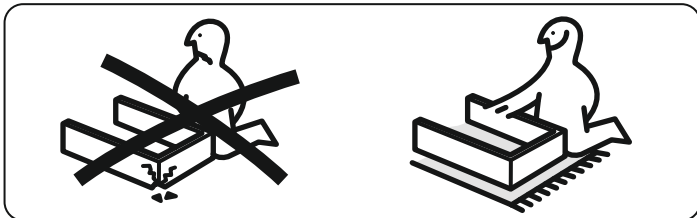
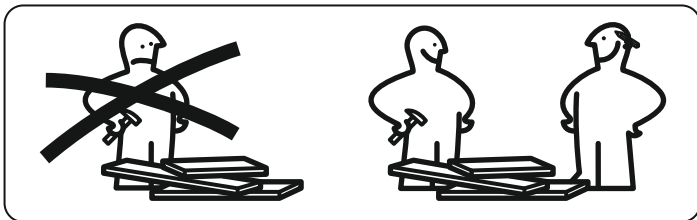

**ASISTENTA: 0371.71.79.79 SAU
OFFICE@MOBMAN.RO**



MOBMAN™

www.mobman.ro

INSTRUCTIUNI TEHNICE GENERALE PENTRU MONTAJ MOBILIER

- VERIFICATI COMPATIBILITATEA PIESELOR SI ACCESORIILOR INAINTE DE MONTAJ.
- PENTRU MONTAJUL MOBILIERULUI, RECOMANDAM FOLOSIREA SERVICIILOR PERSOANELOR CALIFICATE.
- FACETI MONTAJUL PE O SUPRAFATA ACOPERITA CU PANZA SAU CARTON PENTRU A EVITA ZGARIETURILE.

INGRIJIREA SI INTRETINEREA MOBILIERULUI

- EVITATI CONTACTUL PRELUNGIT CU APA SAU CU ABURI.
- PASTRATI O DISTANTA CORESPUNZATOARE FATA DE APARATE ELECTRICE SI INCALZITOARE.
- INDEPARTATI MURDARIA CU O CARPA UMEDA APOI STERGETI. NU UTILIZATI MATERIALE ABRAZIVE.

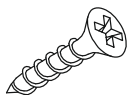
1Surub
3,5x16**x12****W1**

Placa de montare

**x6****P6**

Cuiet

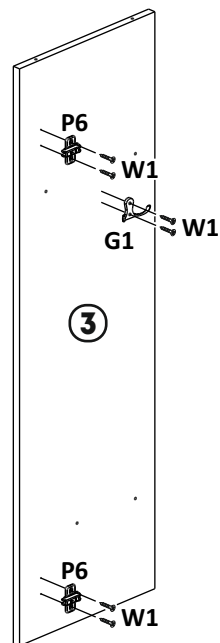
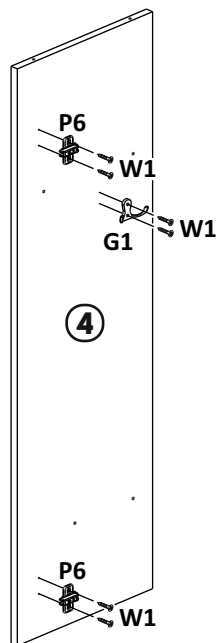
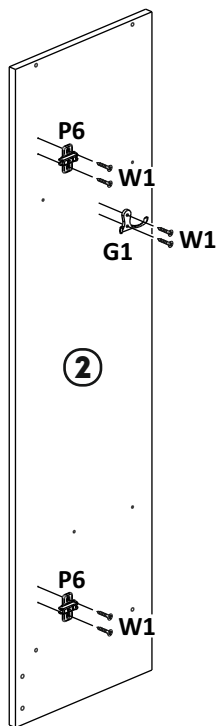
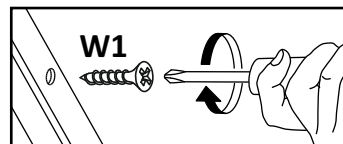
**x3****G1**

2

Eurosurub

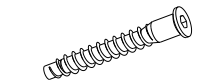

x8

A1

Capac surub

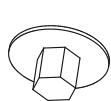

x8

A2

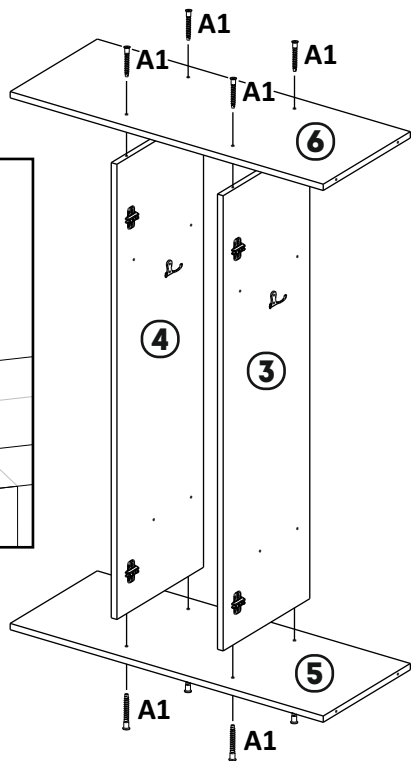
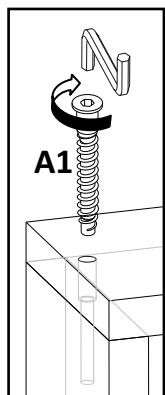
**3**

Eurosurub

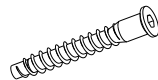

x8

A1

Suport polita

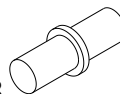

x28

L1

Diblu

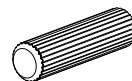

x6

C1

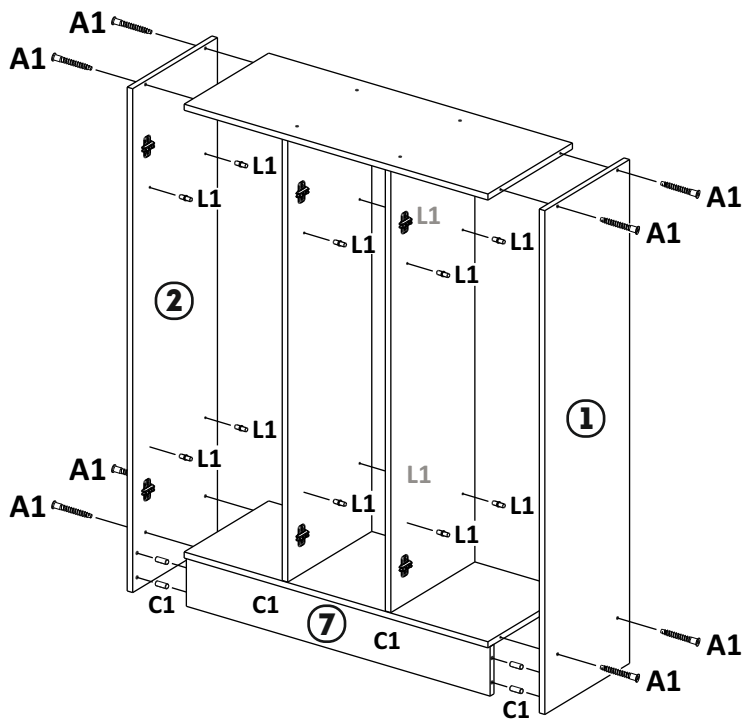

4

Alunecator plastic

x4

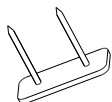

Q3

Clema fixare

x6

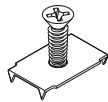

K3

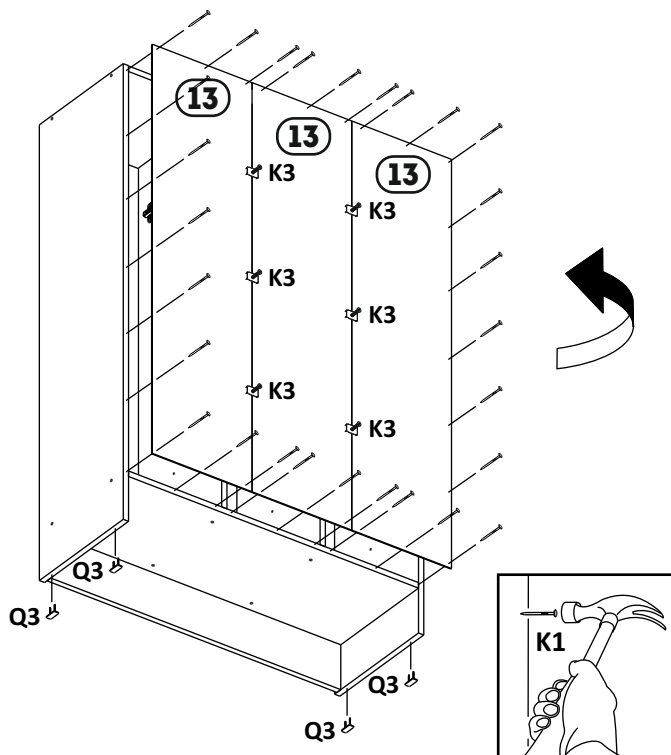
**5**Amortizor de ușă
(silicon)

x6



B4

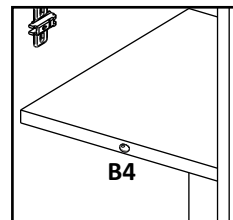

B4

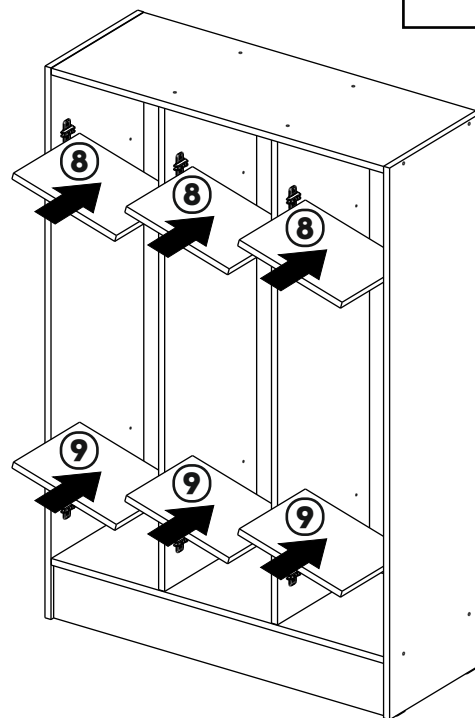

6

Balama incorporata

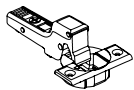

x6

P8

Surub
3,5x16

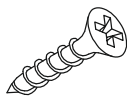

x12

W1

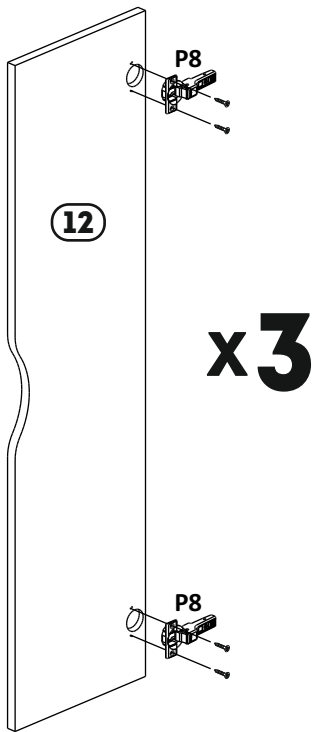

7

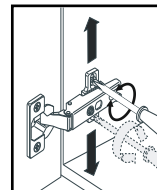
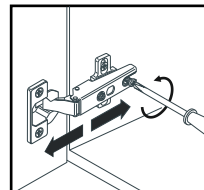
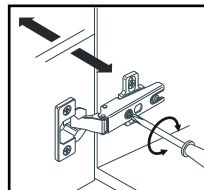
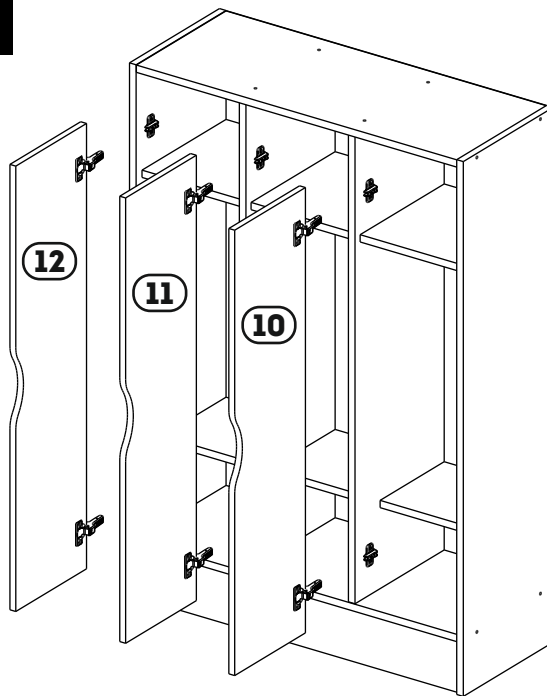

8