

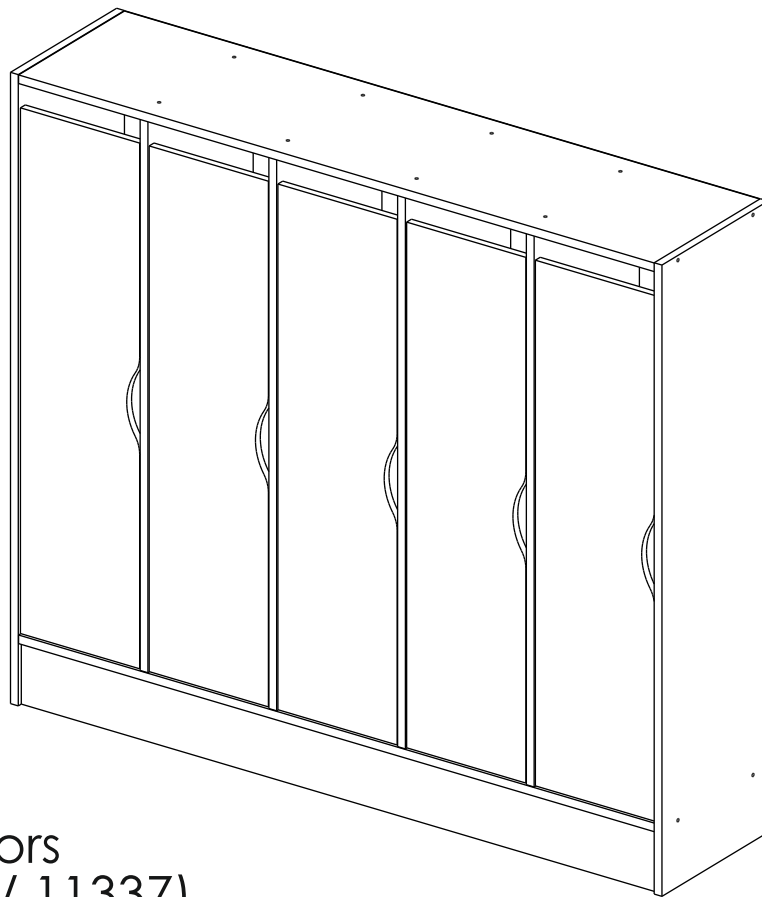

MOBMAN™

www.mobman.ro



Corpus for Oliver 5 doors
(Model 11335 / 11336 / 11337)

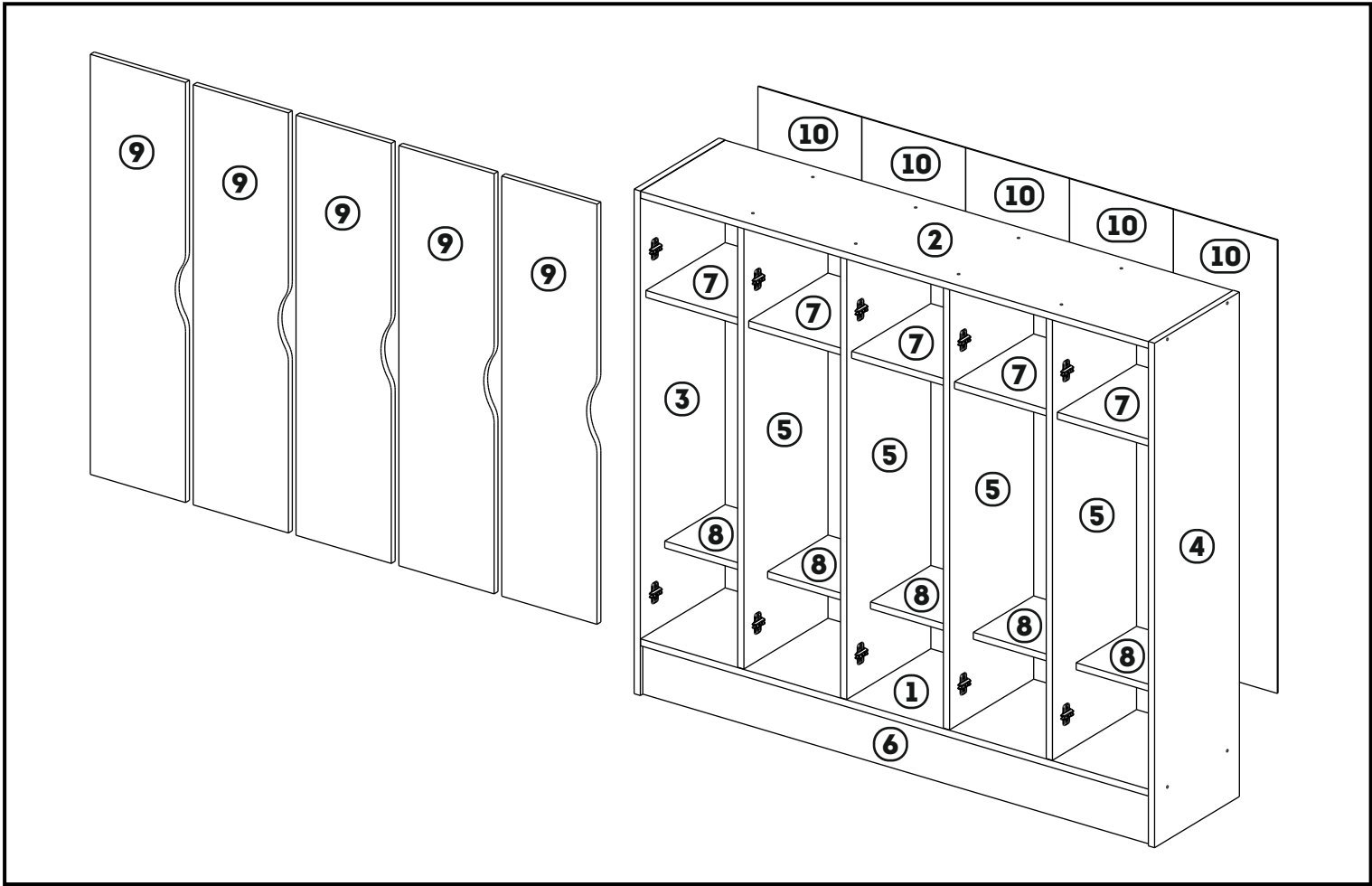

No	a*b	X
1	1472x350	1
2	1472x350	1
3	1321x351	1
4	1321x351	1
5	1154x348	4
6	1472x130	1
7	280x328	5
8	280x250	5
9	1100x276	5
10	1187x301	5

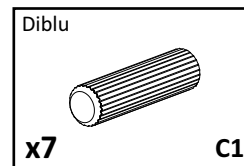
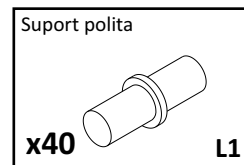
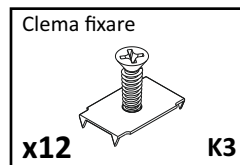
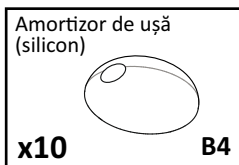
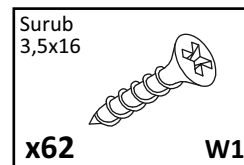
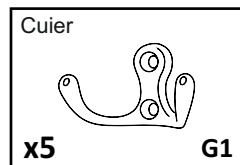
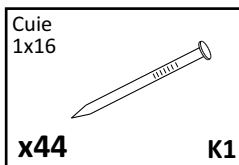
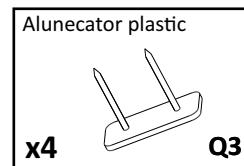
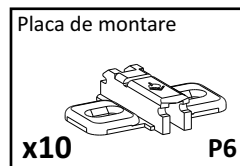
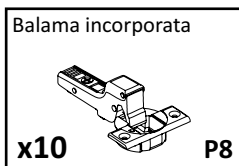
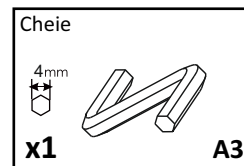
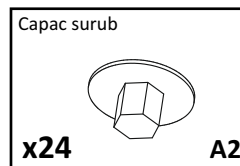
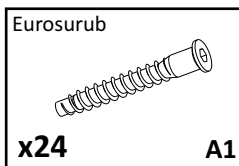

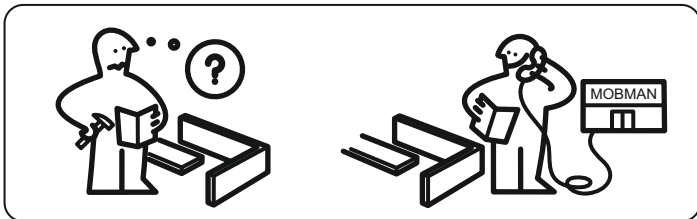
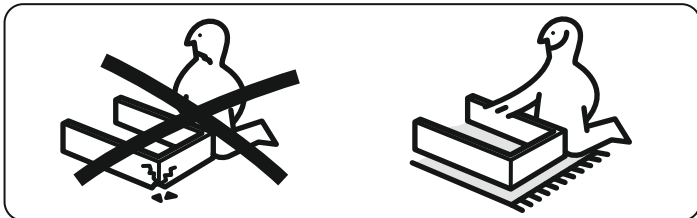
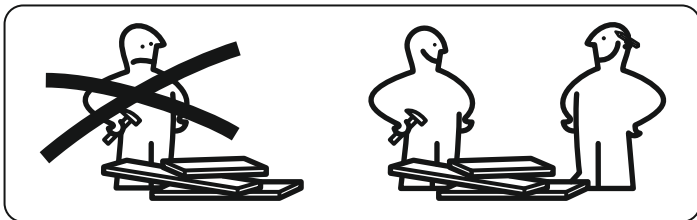

**ASISTENTA: 0371.71.79.79 SAU
OFFICE@MOBMAN.RO**



MOBMAN™

www.mobman.ro

INSTRUCTIUNI TEHNICE GENERALE PENTRU MONTAJ MOBILIER

- VERIFICATI COMPATIBILITATEA PIESELOR SI ACCESORIILOR INAINTE DE MONTAJ.
- PENTRU MONTAJUL MOBILIERULUI, RECOMANDAM FOLOSIREA SERVICIILOR PERSOANELOR CALIFICATE.
- FACETI MONTAJUL PE O SUPRAFATA ACOPERITA CU PANZA SAU CARTON PENTRU A EVITA ZGARIETURILE.

INGRIJIREA SI INTRETINEREA MOBILIERULUI

- EVITATI CONTACTUL PRELUNGIT CU APA SAU CU ABURI.
- PASTRATI O DISTANTA CORESPUNZATOARE FATA DE APARATE ELECTRICE SI INCALZITOARE.
- INDEPARTATI MURDARIA CU O CARPA UMEDA APOI STERGETI. NU UTILIZATI MATERIALE ABRAZIVE.

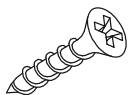
1Surub
3,5x16**x30****W1**

Placa de montare

**x10****P6**

Cuiier

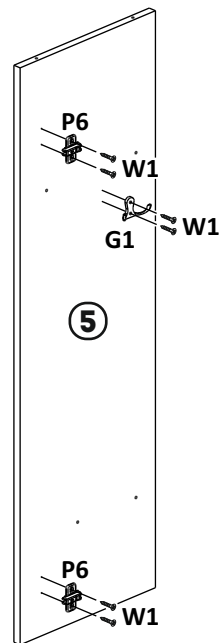
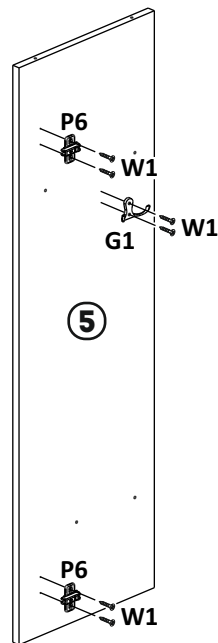
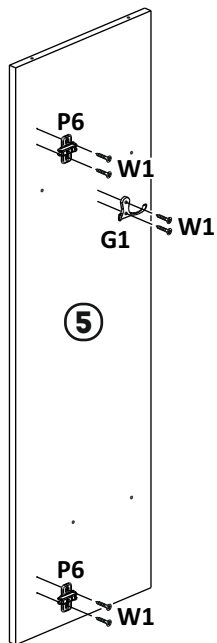
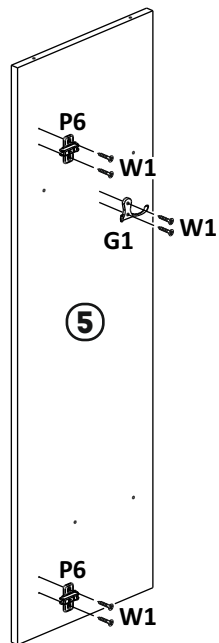
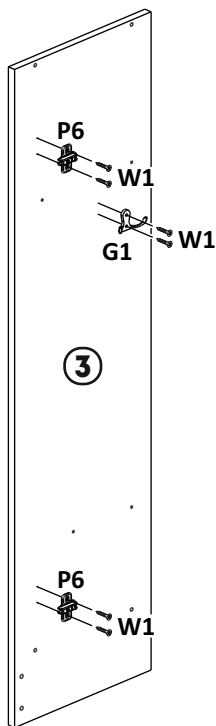
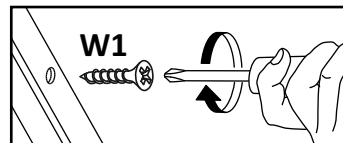
**x5****G1**

2

Eurosurub

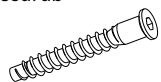

x16

A1

Capac surub

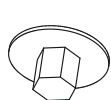

x16

A2

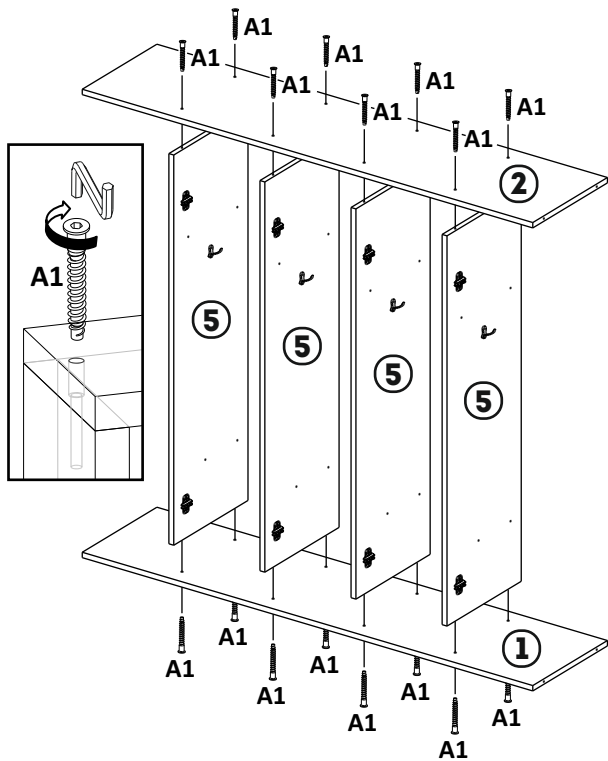
**3**

Eurosurub

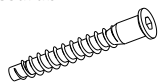

x8

A1

Suport polita

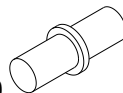

x40

L1

Diblu

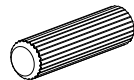

x7

C1

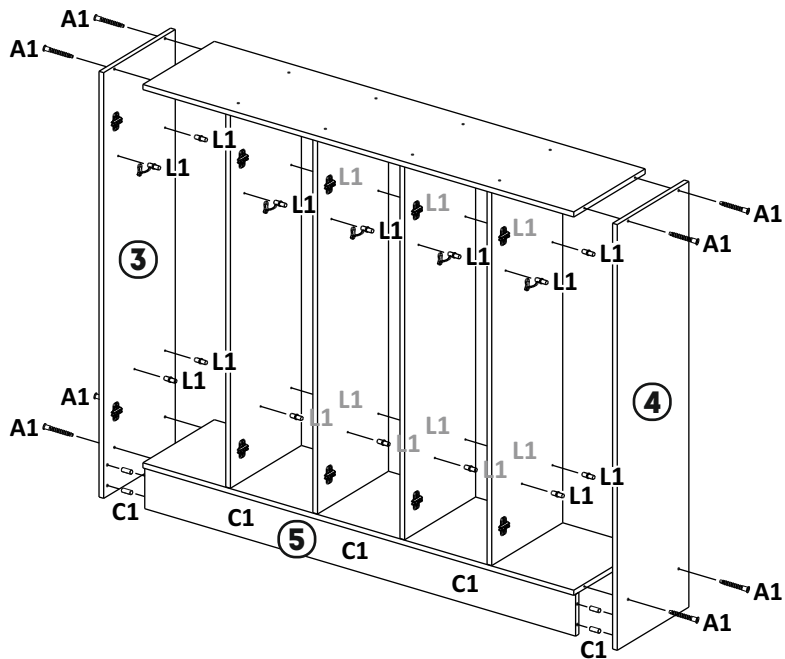

4

Alunecator plastic

x4

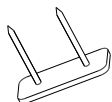

Q3

Clema fixare

x12

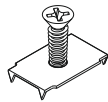

K3

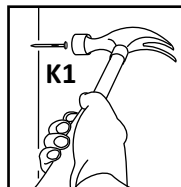
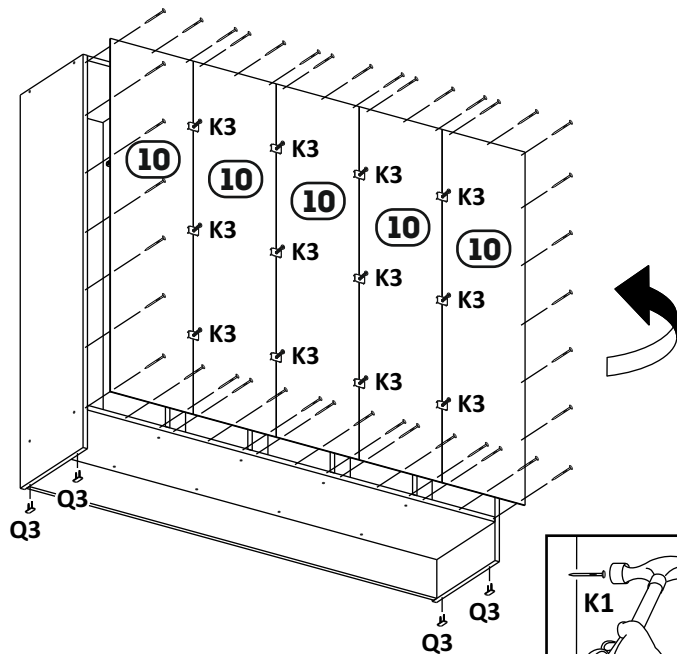
**5**Amortizor de ușă
(silicon)

x10



B4

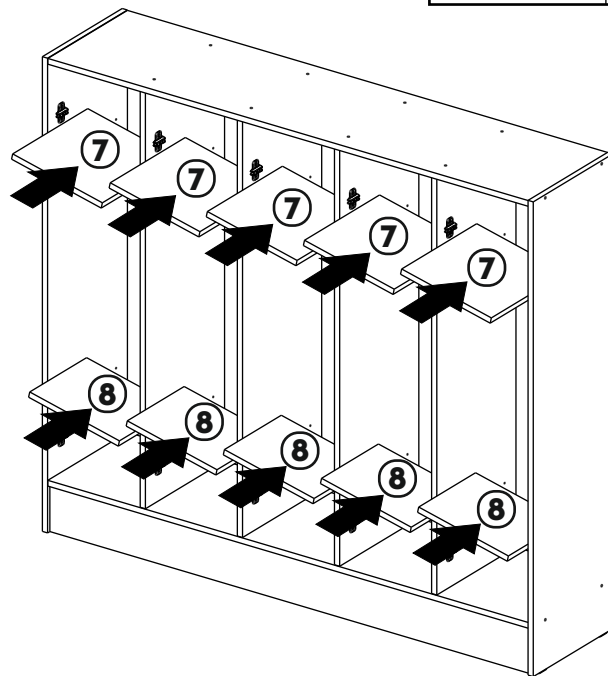
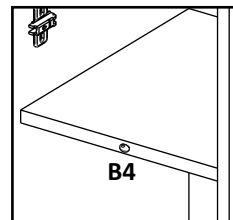

6

Balama incorporata

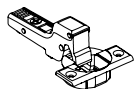

x2

P8

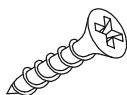
Surub
3,5x16

x4

W1

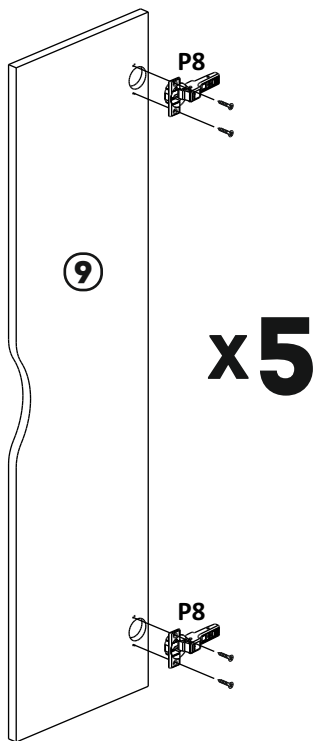
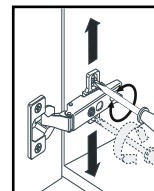
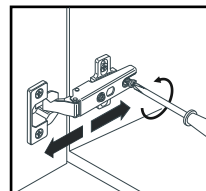
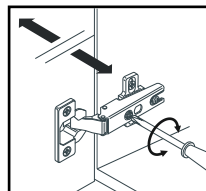
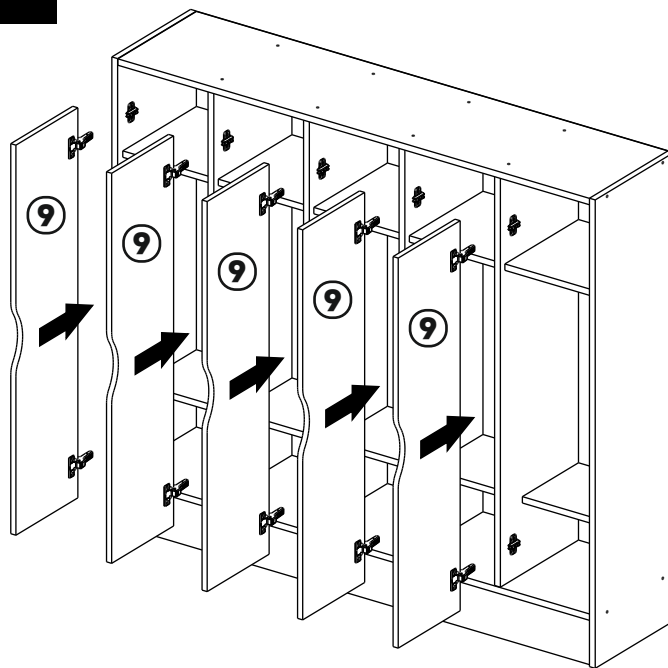
**7****8**