

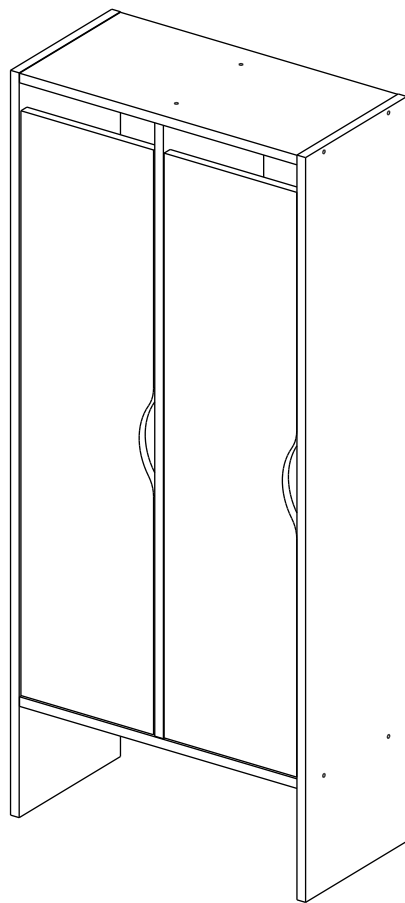

**MOBMAN™**

[www.mobman.ro](http://www.mobman.ro)

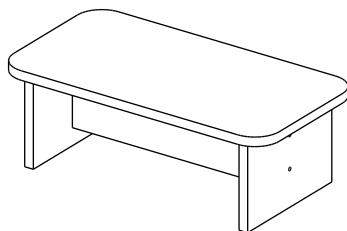

Vestiar gradinita  
Oliver PRO cu 2 usi  
(Model 11338 / 11339 / 11340)

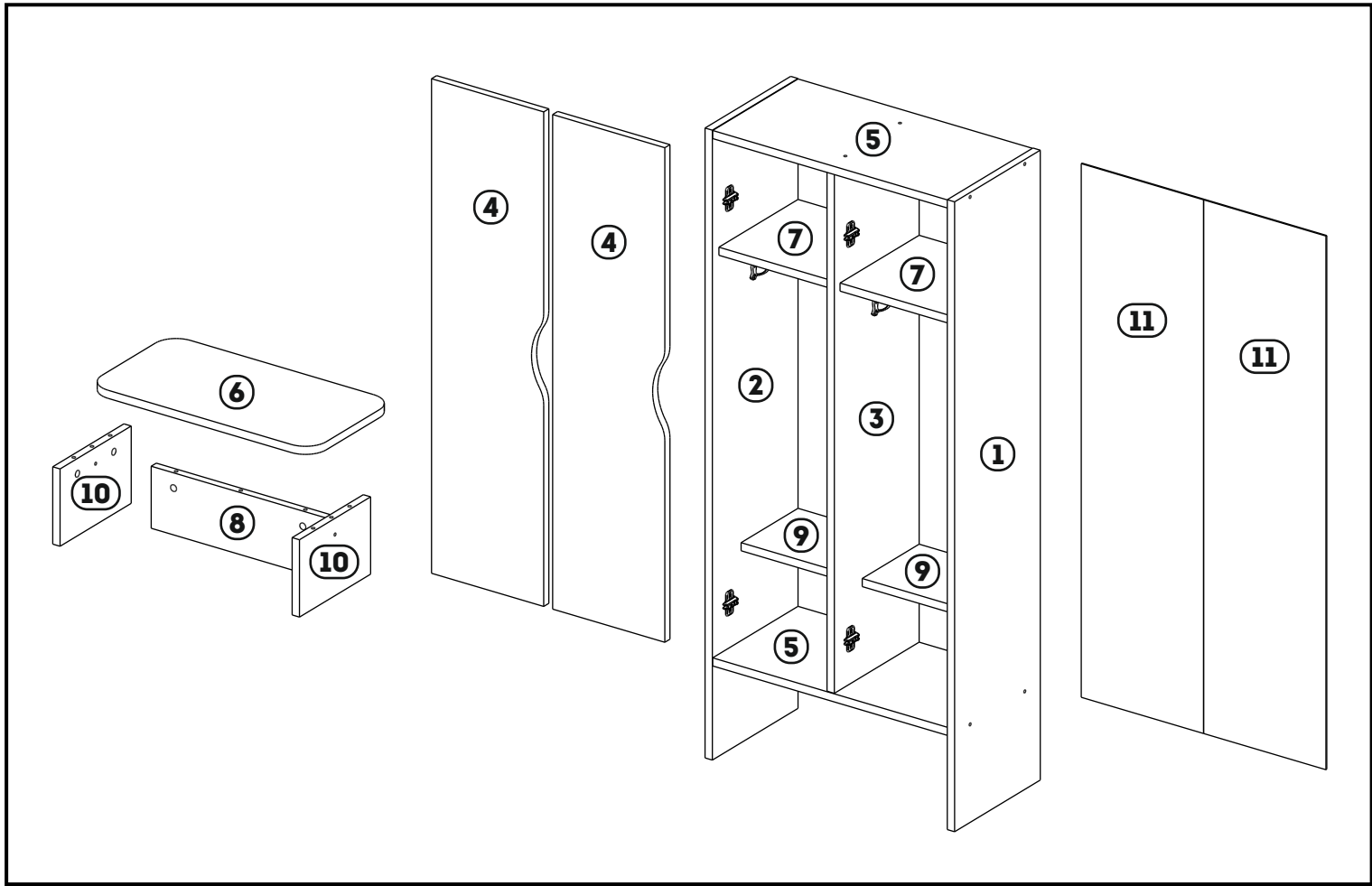

No	a*b	X
1	1401x301	1
2	1401x301	1
3	1155x298	1
4	1100x276	2
5	578x300	2
6	552x290	1
7	280x278	2
8	138x428	1
9	280x200	2
10	172x250	2
11	1187x301	2

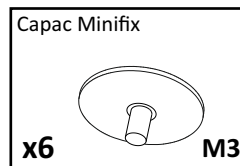
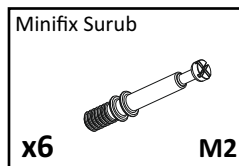
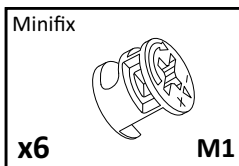
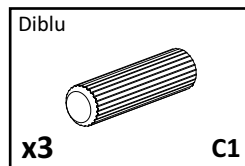
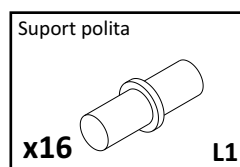
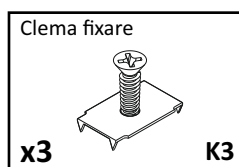
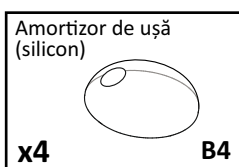
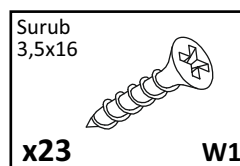
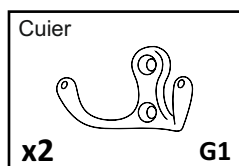
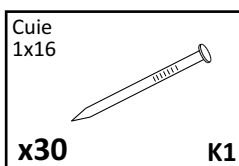
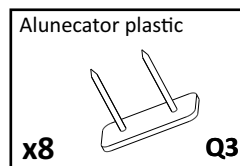
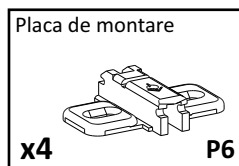
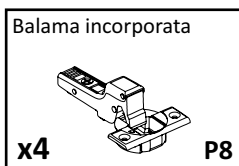
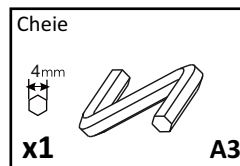
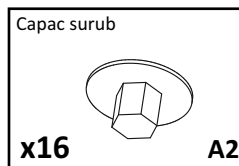
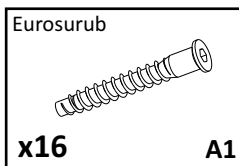

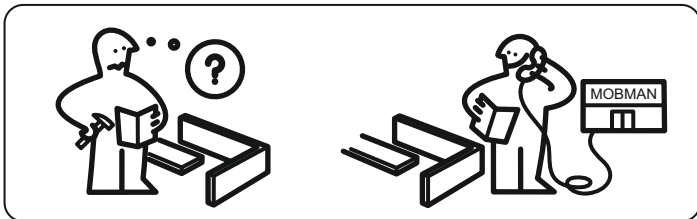
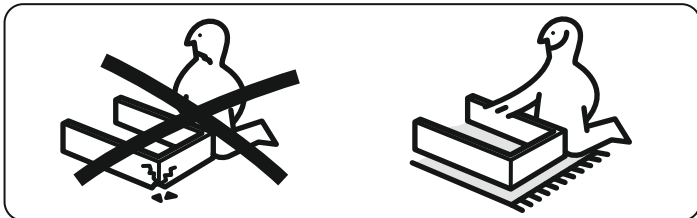
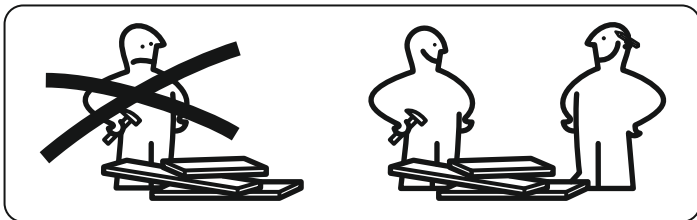

**ASISTENTA: 0371.71.79.79 SAU  
OFFICE@MOBMAN.RO**



**MOBMAN™**

www.mobman.ro

## **INSTRUCTIUNI TEHNICE GENERALE PENTRU MONTAJ MOBILIER**

- VERIFICATI COMPATIBILITATEA PIESELOR SI ACCESORIILOR INAINTE DE MONTAJ.
- PENTRU MONTAJUL MOBILIERULUI, RECOMANDAM FOLOSIREA SERVICIILOR PERSOANELOR CALIFICATE.
- FACETI MONTAJUL PE O SUPRAFATA ACOPERITA CU PANZA SAU CARTON PENTRU A EVITA ZGARIETURILE.

## **INGRIJIREA SI INTRETINEREA MOBILIERULUI**

- EVITATI CONTACTUL PRELUNGIT CU APA SAU CU ABURI.
- PASTRATI O DISTANTA CORESPUNZATOARE FATA DE APARATE ELECTRICE SI INCALZITOARE.
- INDEPARTATI MURDARIA CU O CARPA UMEDA APOI STERGETI. NU UTILIZATI MATERIALE ABRAZIVE.

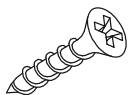
**1**Surub  
3,5x16**x12****W1**

Placa de montare

**x4****P6**

Cuiet

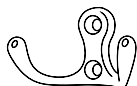
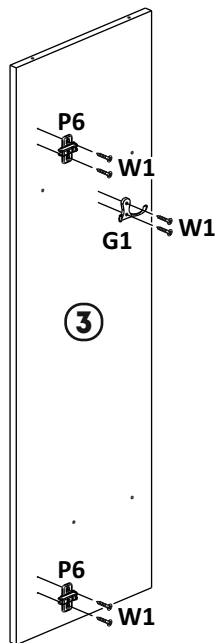
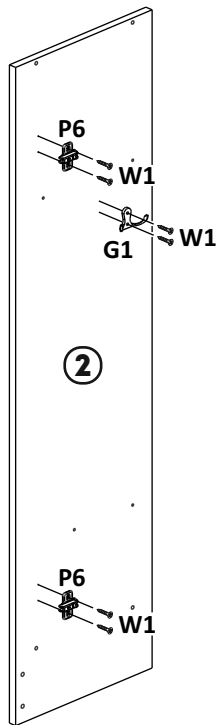
**x2****G1****2**

Eurosurub

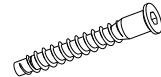
**x4****A1**

Capac surub

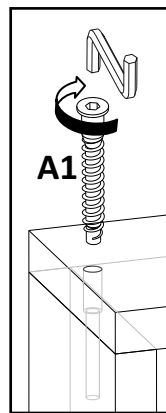
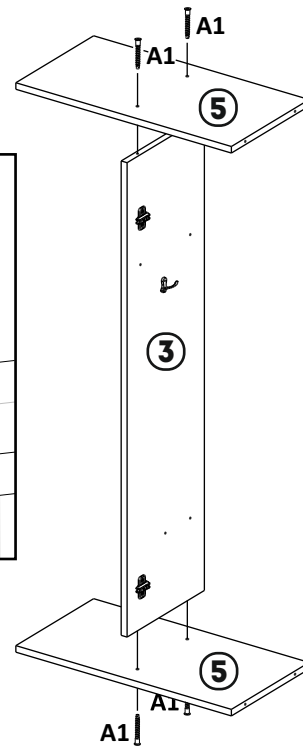
**x4****A2****A1**

**3**

Eurosurub

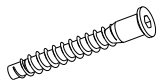

x8

A1

Suport polita

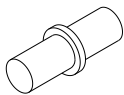

x16

L1

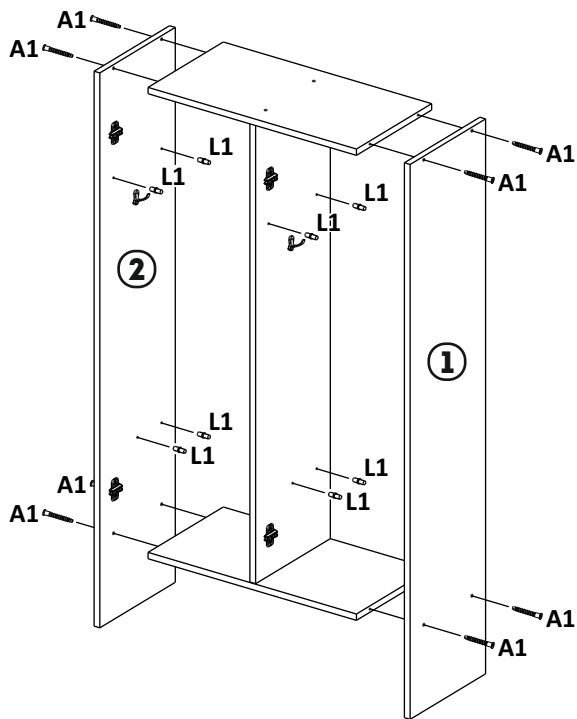
**4**

Alunecator plastic

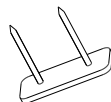

x4

Q3

Clema fixare

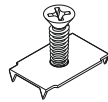

x3

K3

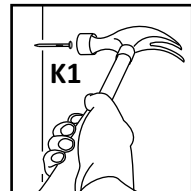
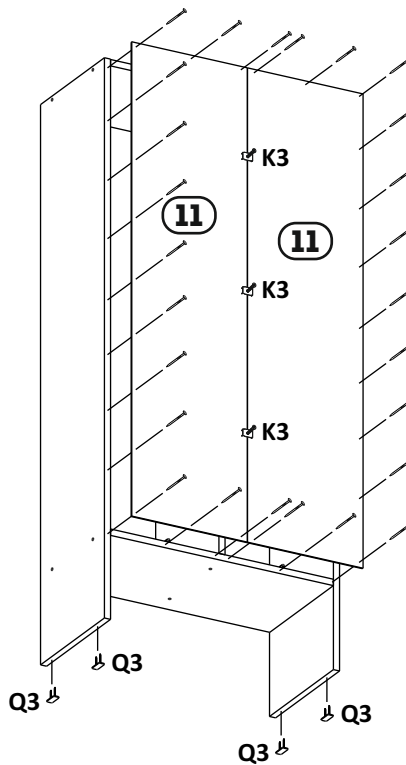

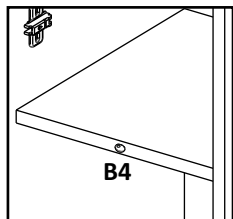
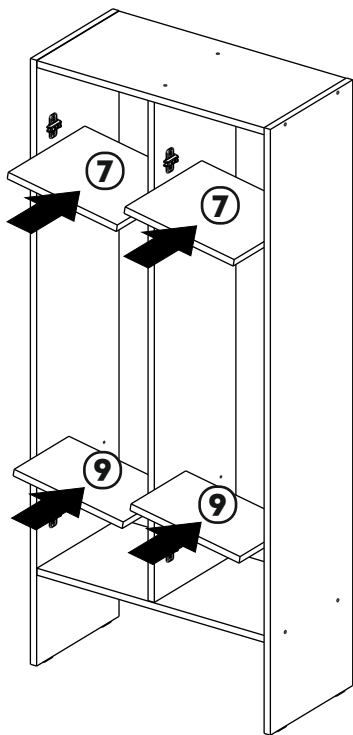
**5**Amortizor de ușă  
(silicon)**x4****B4****B4****6**

Minifix

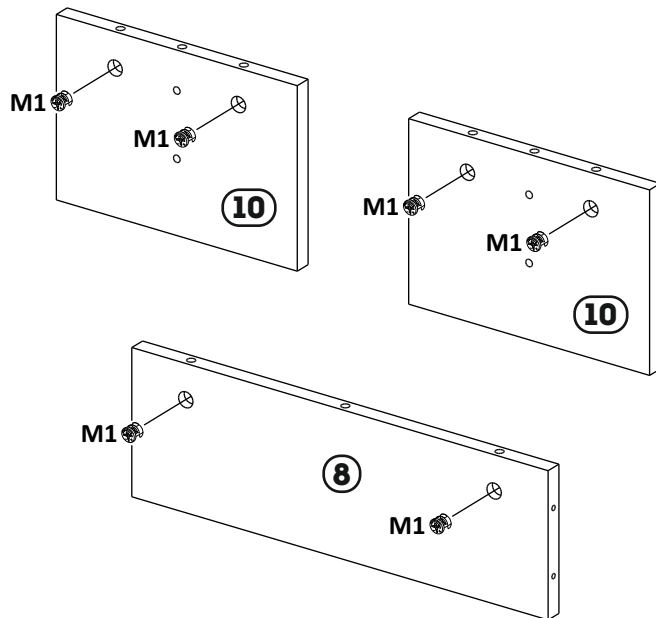
**x6****M1**

**7**

Eurosurb

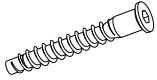
**x4****A1**

Capac surub

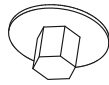
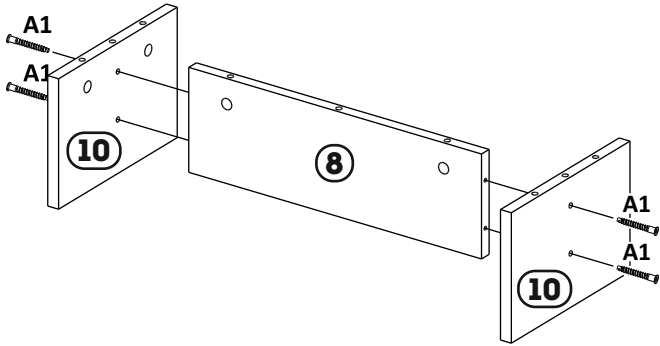
**x4****A2****8**

Alunecator plastic

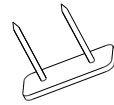
**x4****Q3**

Diblu

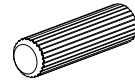
**x3****C1**

Minifix Surub

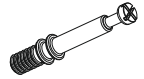
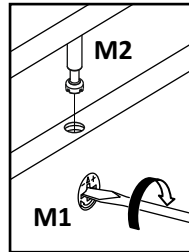
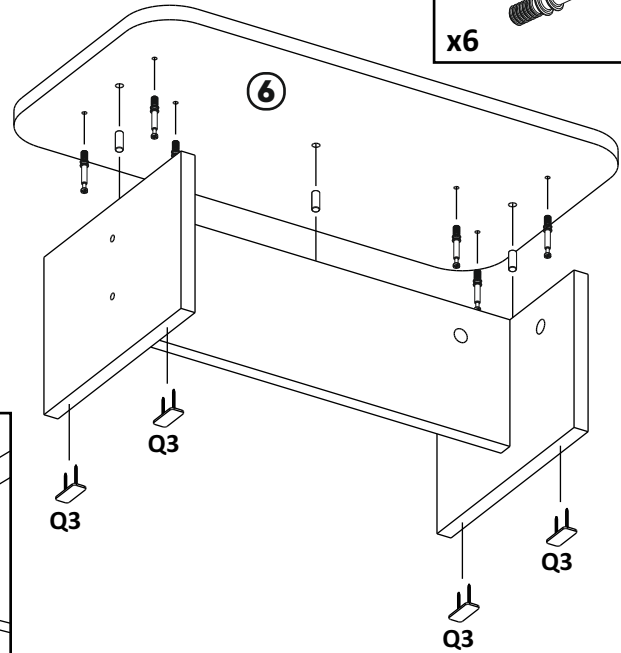
**x6****M2****8**



# 9

Balama incorporata

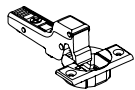

x2

P8

Surub  
3,5x16

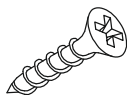

x4

W1

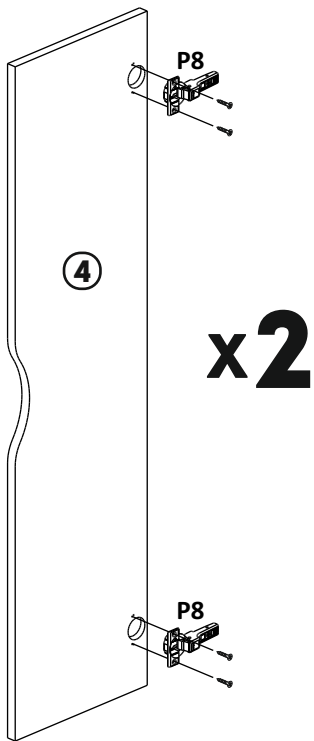

# 10

