

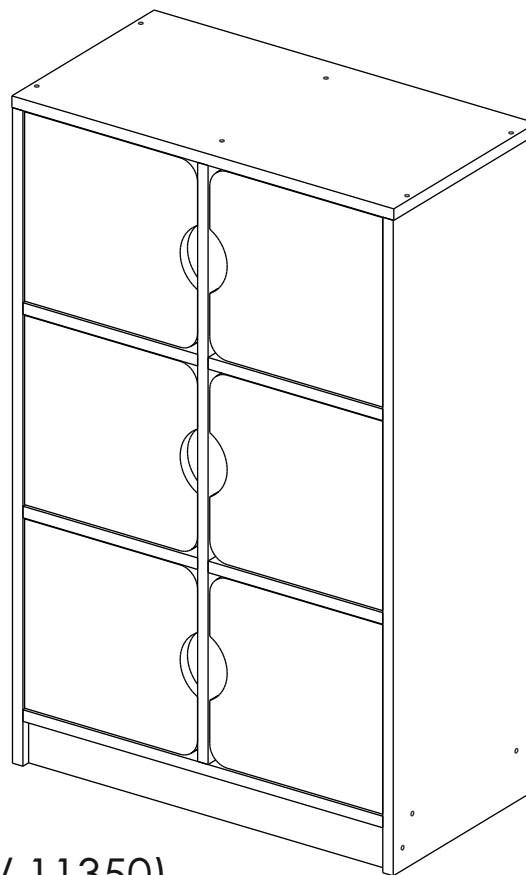

MOBMAN™

www.mobman.ro



Dulap gradinita Oliver

(cu 6 usi)

(Model 11347 / 11348 / 11349 / 11350)

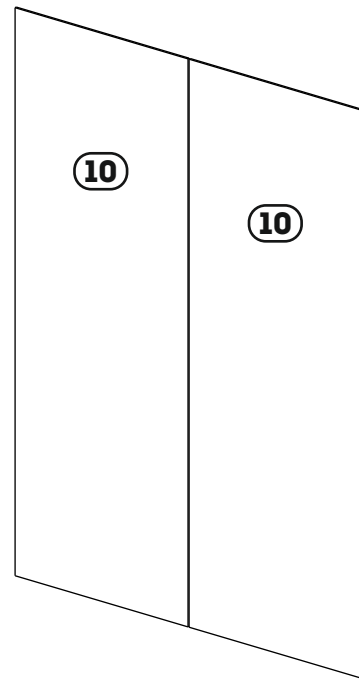
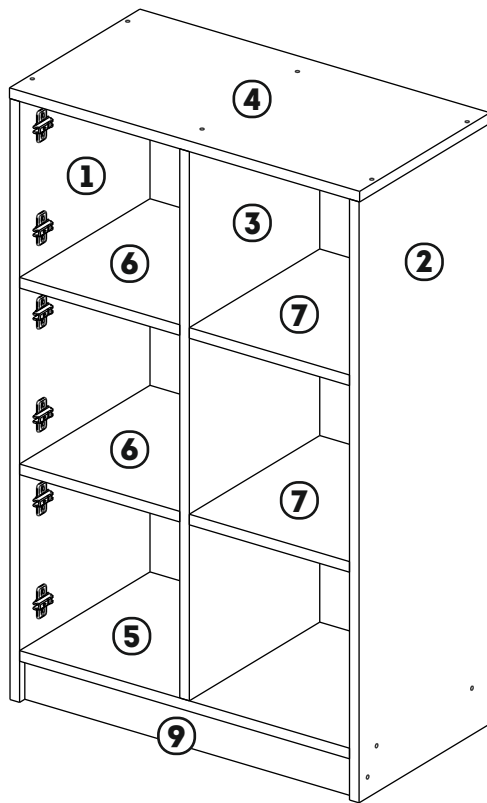
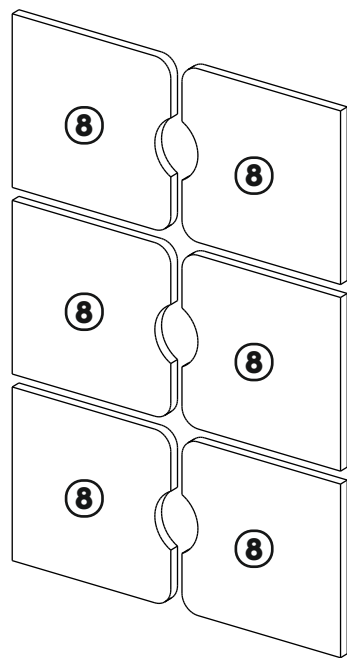

No	a*b	X
1	1021x350	1
2	1021x350	1
3	933x350	1
4	658x350	1
5	620x350	1
6	301x350	2
7	301x350	2
8	295x298	6
9	620x70	1
10	965x325	2

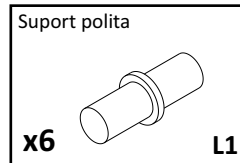
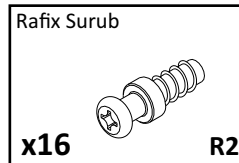
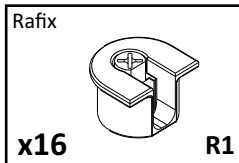
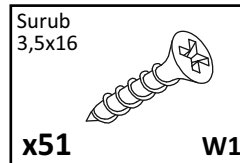
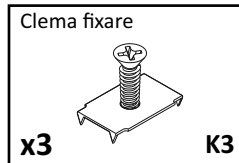
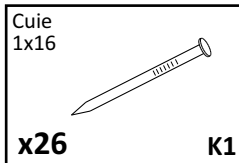
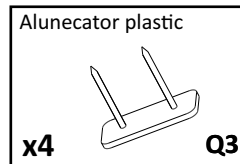
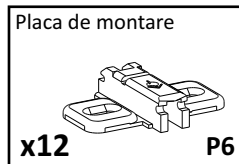
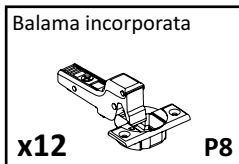
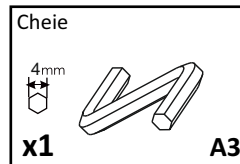
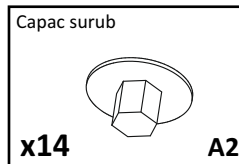
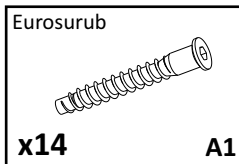

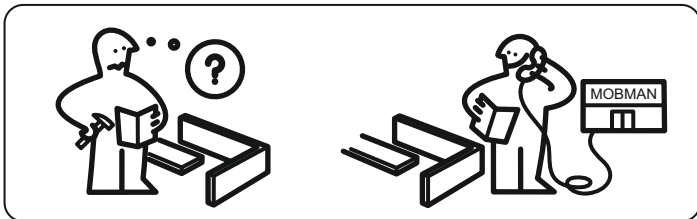
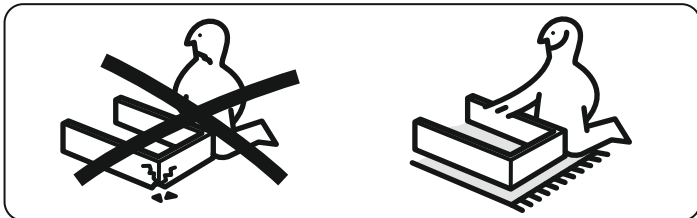
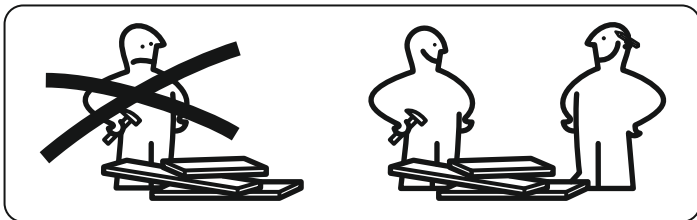

**ASISTENTA: 0371.71.79.79 SAU
OFFICE@MOBMAN.RO**



MOBMAN™

www.mobman.ro

INSTRUCTIUNI TEHNICE GENERALE PENTRU MONTAJ MOBILIER

- VERIFICATI COMPATIBILITATEA PIESELOR SI ACCESORIILOR INAINTE DE MONTAJ.
- PENTRU MONTAJUL MOBILIERULUI, RECOMANDAM FOLOSIREA SERVICIILOR PERSOANELOR CALIFICATE.
- FACETI MONTAJUL PE O SUPRAFATA ACOPERITA CU PANZA SAU CARTON PENTRU A EVITA ZGARIETURILE.

INGRIJIREA SI INTRETINEREA MOBILIERULUI

- EVITATI CONTACTUL PRELUNGIT CU APA SAU CU ABURI.
- PASTRATI O DISTANTA CORESPUNZATOARE FATA DE APARATE ELECTRICE SI INCALZITOARE.
- INDEPARTATI MURDARIA CU O CARPA UMEDA APOI STERGETI. NU UTILIZATI MATERIALE ABRAZIVE.

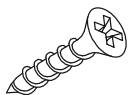
1Surub
3,5x16**x24****W1**

Placa de montare

**x12****P6****2**

Eurosurub

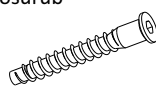
**x8****A1**

Capac surub

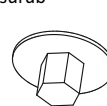
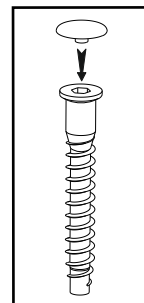
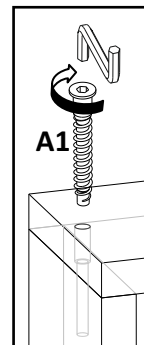
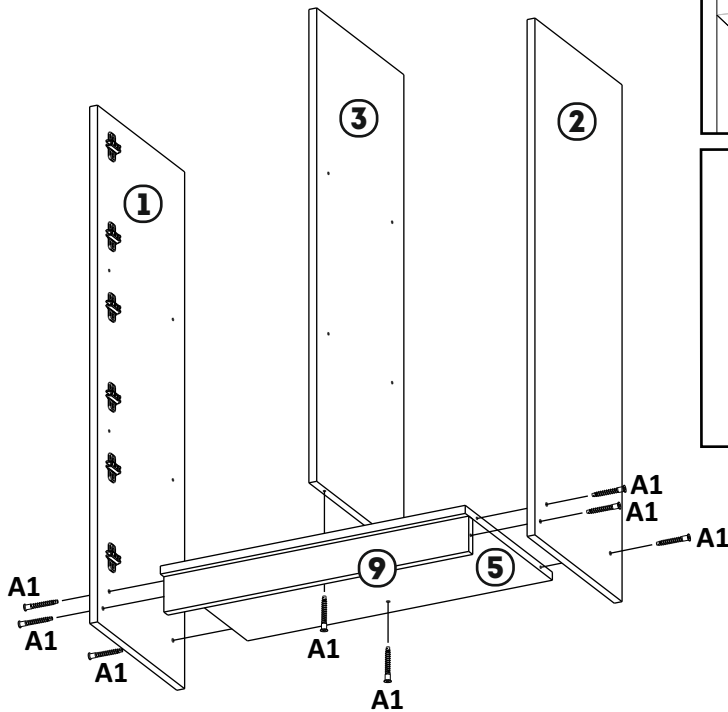
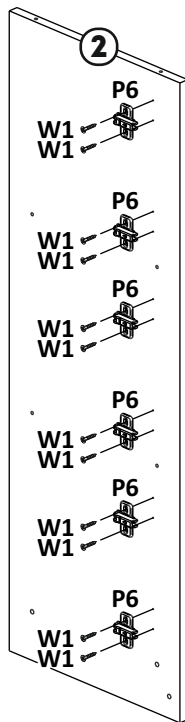
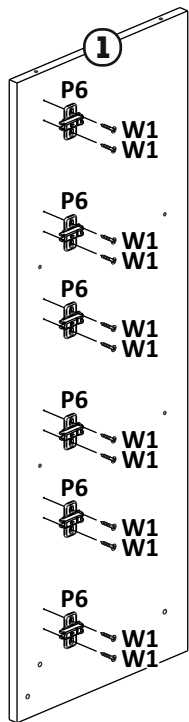
**x8****A2**

3

Eurosurub

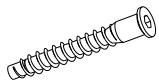

x6

A1

Capac surub



x6

A2

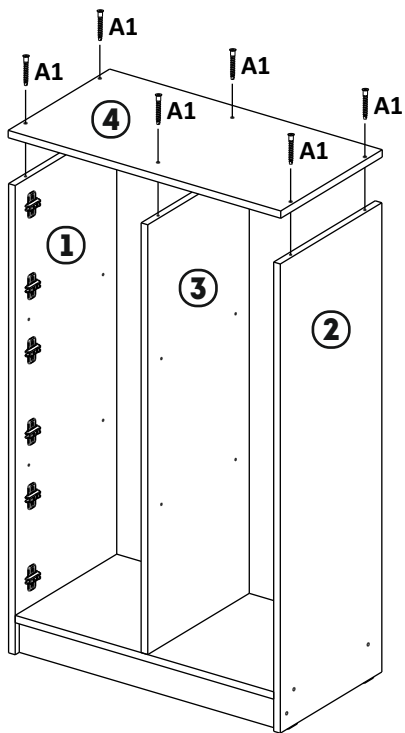

4

Alunecator plastic

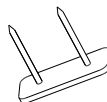

x4

Q3

Clema fixare

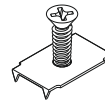

x3

K3

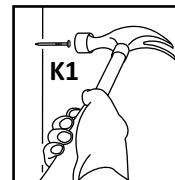
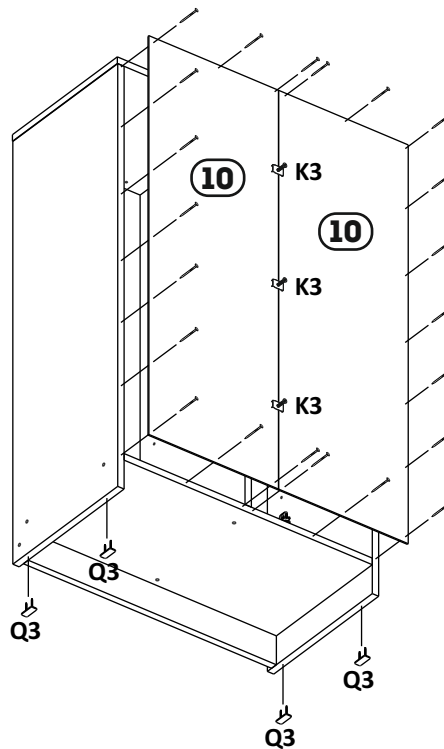

5

Surub Rafix

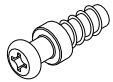

x16

R2

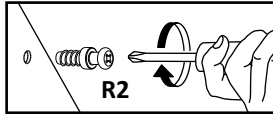

6

Rafix

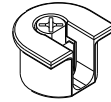

x8

R1

Suport polita

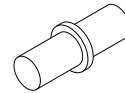

x2

L1

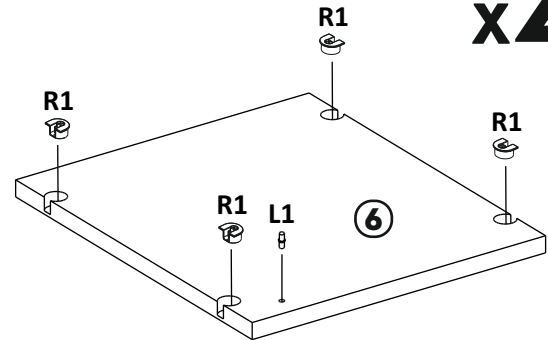
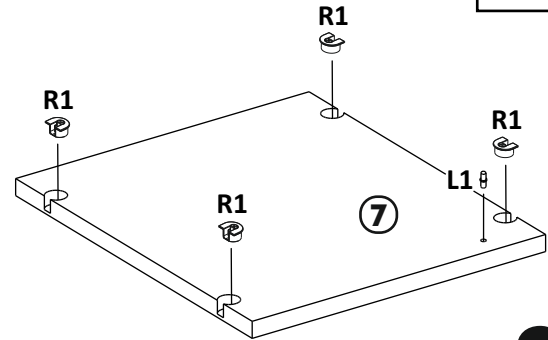
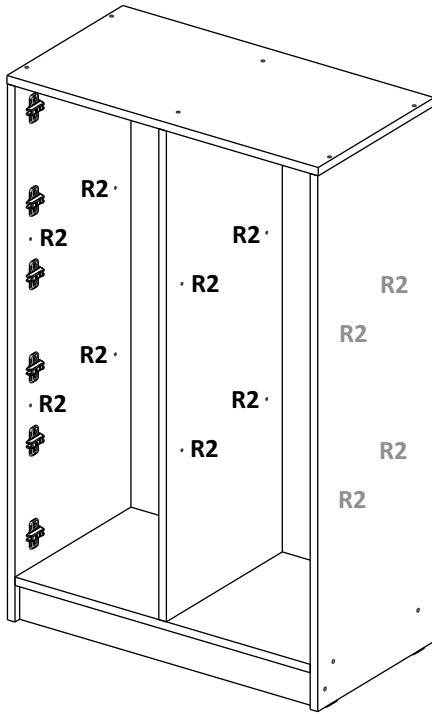
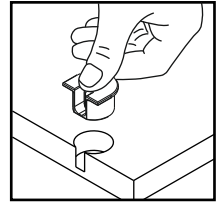

x2

7

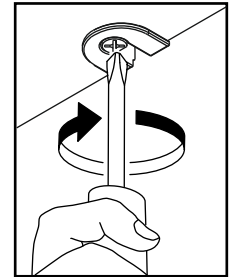
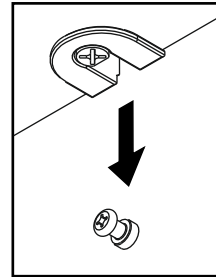
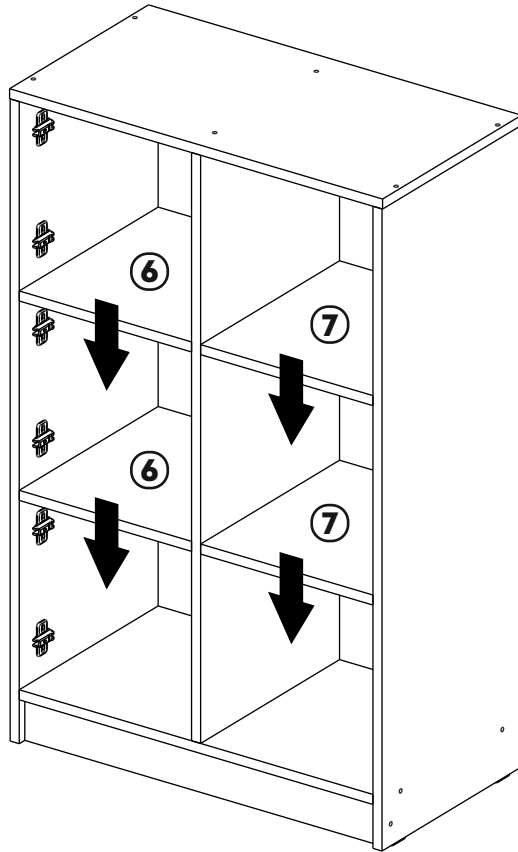

8

8

Balama incorporata

x2

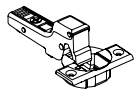

P8

Surub
3,5x16

x4

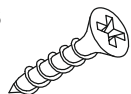

W1

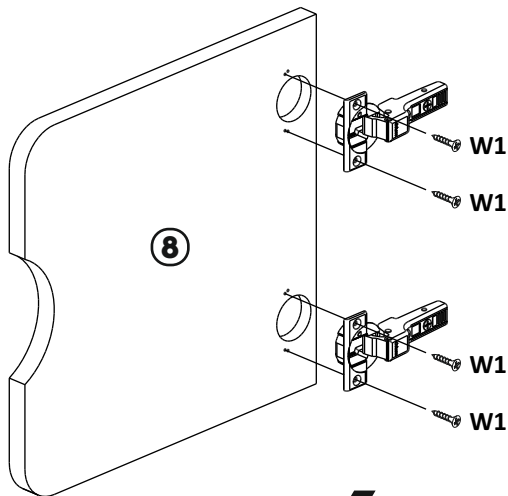

x6

9

