

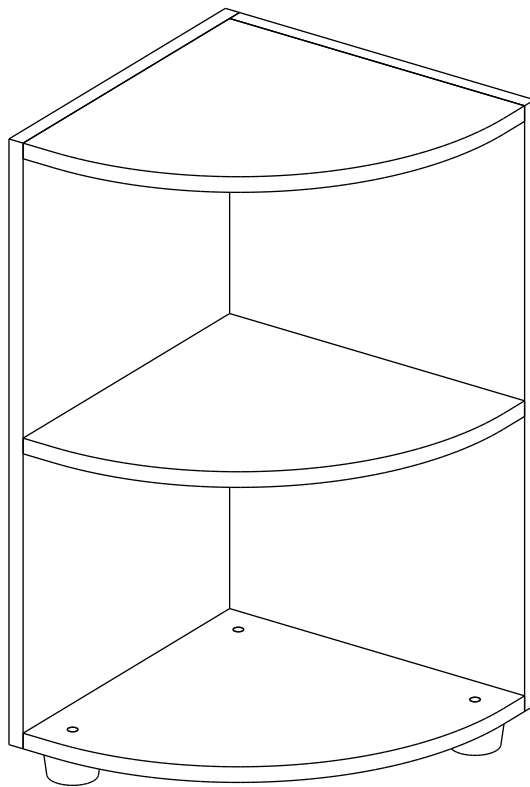

MOBMAN™

www.mobman.ro



11352
Corp colt mobilier
gradinita Oliver
(cu 1 polita O1)

| No | a*b | Bucati |
|----|---------|--------|
| 1 | 332x332 | 2 |
| 2 | 332x332 | 1 |
| 3 | 620x350 | 1 |
| 4 | 620x332 | 1 |

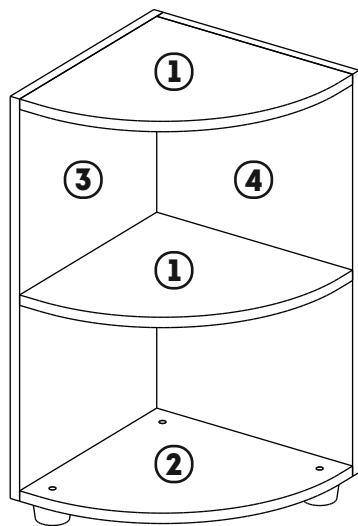
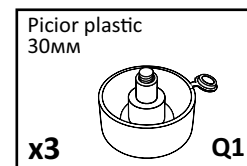
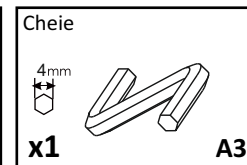
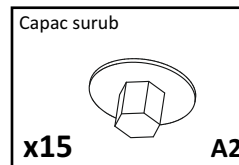
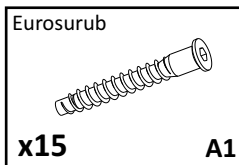

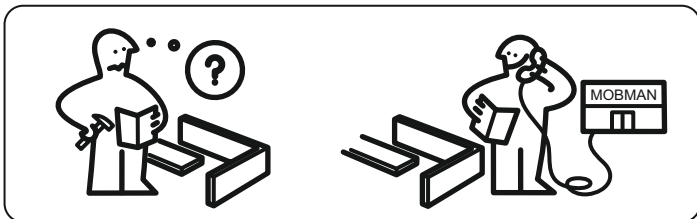
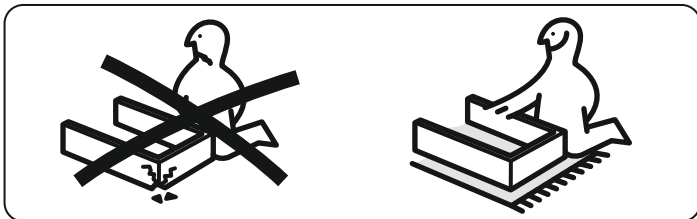
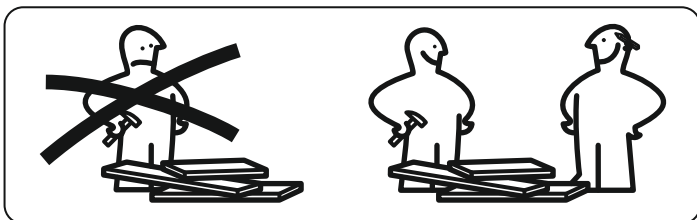

**ASISTENTA: 0371.71.79.79 SAU
OFFICE@MOBMAN.RO**



MOBMAN™

www.mobman.ro

INSTRUCTIUNI TEHNICE GENERALE PENTRU MONTAJ MOBILIER

- VERIFICATI COMPATIBILITATEA PIESELOR SI ACCESORIILOR INAINTE DE MONTAJ.
- PENTRU MONTAJUL MOBILIERULUI, RECOMANDAM FOLOSIREA SERVICIILOR PERSOANELOR CALIFICATE.
- FACETI MONTAJUL PE O SUPRAFATA ACOPERITA CU PANZA SAU CARTON PENTRU A EVITA ZGARIETURILE.

INGRIJIREA SI INTRETINEREA MOBILIERULUI

- EVITATI CONTACTUL PRELUNGIT CU APA SAU CU ABURI.
- PASTRATI O DISTANTA CORESPUNZATOARE FATA DE APARATE ELECTRICE SI INCALZITOARE.
- INDEPARTATI MURDARIA CU O CARPA UMEDA APOI STERGETI. NU UTILIZATI MATERIALE ABRAZIVE.

1

Eurosurub

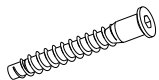
**x12****A1**

Capac surub

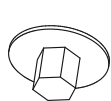
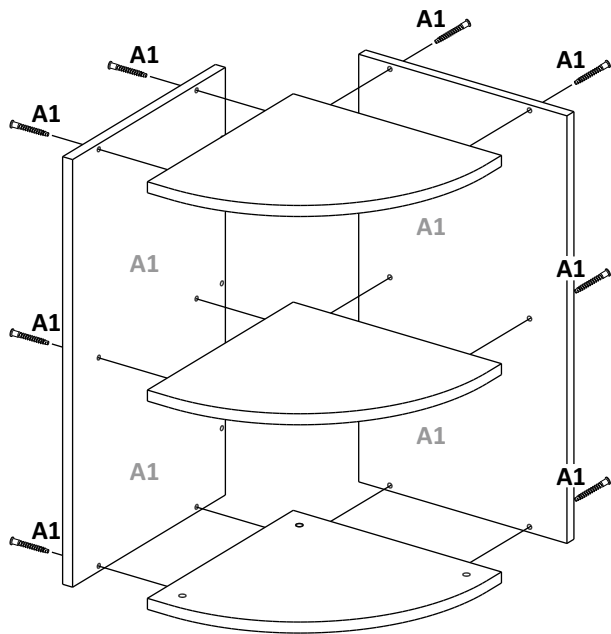
**x12****A2****2**

Eurosurub

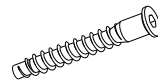
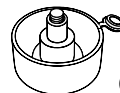
**x3****A1**Picior plastic
30mm**x3****Q1**