

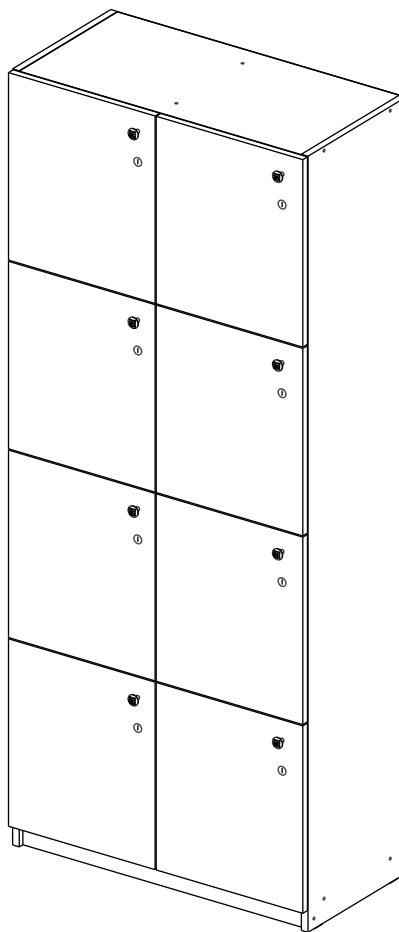

**MOBMAN™**

[www.mobman.ro](http://www.mobman.ro)



Dulap cu  
compartimente  
individuale  
(Model 11552)

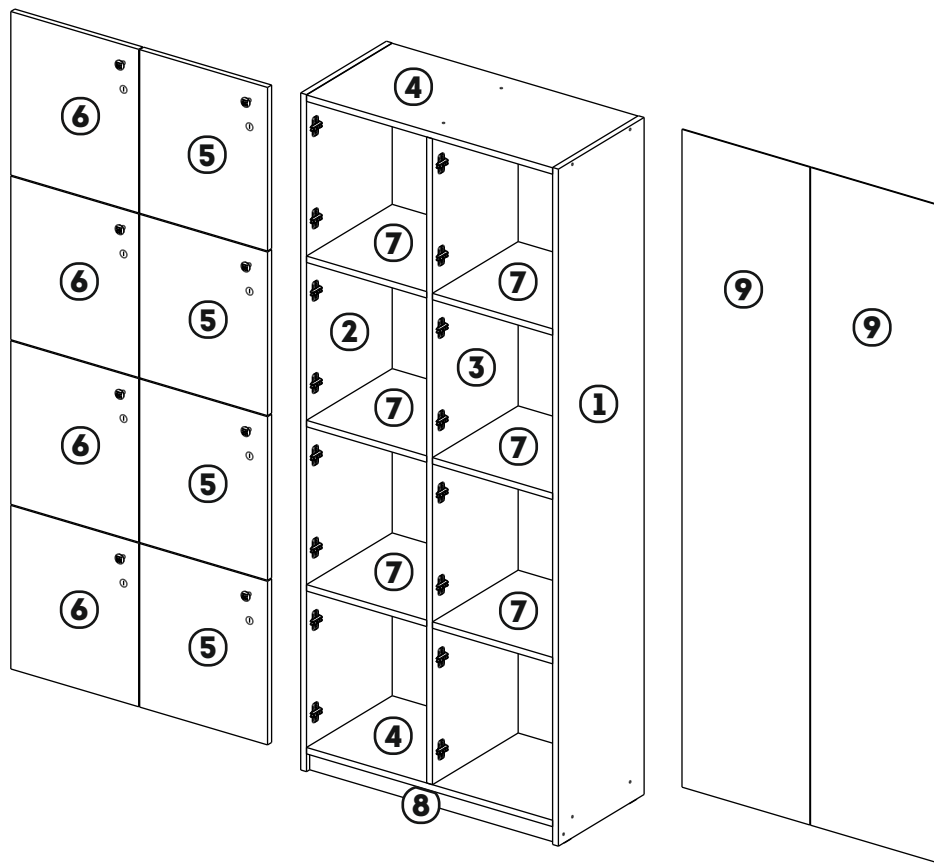

No	a*b	Bucati
1	1900x380	1
2	1900x380	1
3	1813x380	1
4	764x380	2
5	459x397	4
6	459x397	4
7	373x380	6
8	50x764	1

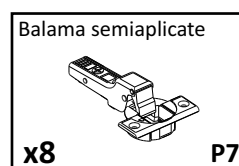
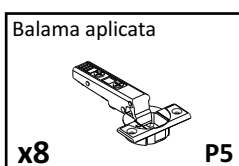
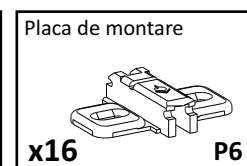
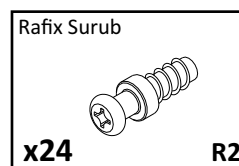
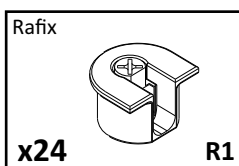
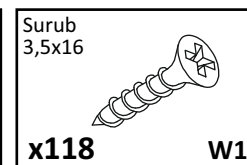
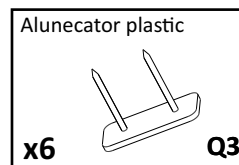
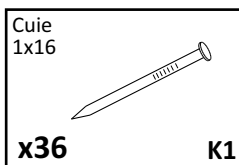
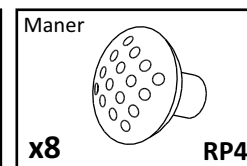
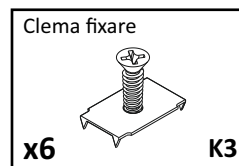
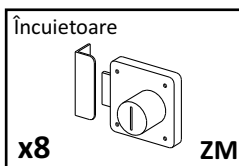
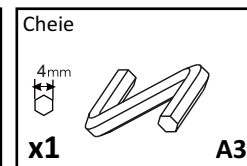
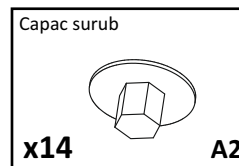
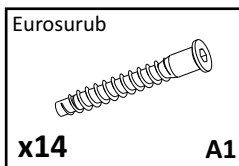

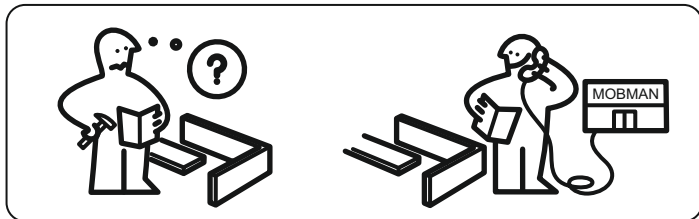
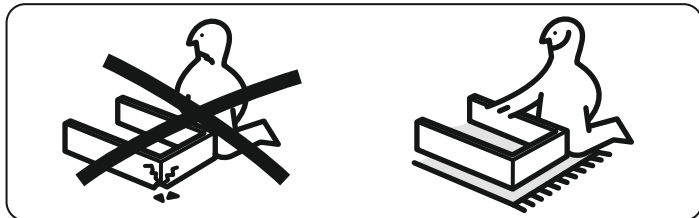
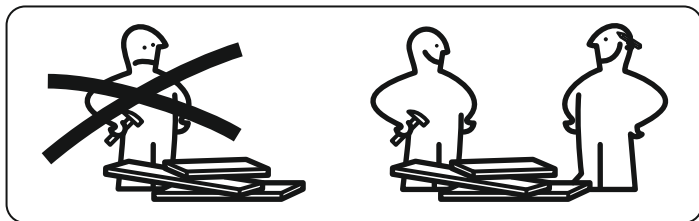

**ASISTENTA: 0371.71.79.79 SAU  
OFFICE@MOBMAN.RO**



**MOBMAN™**

www.mobman.ro

## **INSTRUCTIUNI TEHNICE GENERALE PENTRU MONTAJ MOBILIER**

- VERIFICATI COMPATIBILITATEA PIESELOR SI ACCESORIILOR INAINTE DE MONTAJ.
- PENTRU MONTAJUL MOBILIERULUI, RECOMANDAM FOLOSIREA SERVICIILOR PERSOANELOR CALIFICATE.
- FACETI MONTAJUL PE O SUPRAFATA ACOPERITA CU PANZA SAU CARTON PENTRU A EVITA ZGARIETURILE.

## **INGRIJIREA SI INTRETINEREA MOBILIERULUI**

- EVITATI CONTACTUL PRELUNGIT CU APA SAU CU ABURI.
- PASTRATI O DISTANTA CORESPUNZATOARE FATA DE APARATE ELECTRICE SI INCALZITOARE.
- INDEPARTATI MURDARIA CU O CARPA UMEDA APOI STERGETI. NU UTILIZATI MATERIALE ABRAZIVE.

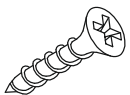
**1**Surub  
3,5x16**x24****W1**

Placa de montare

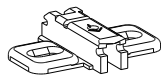
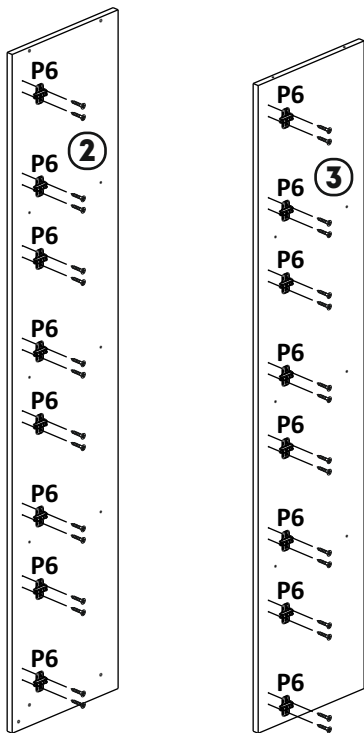
**x12****P6****2**

Eurosurb

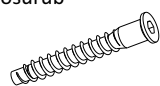
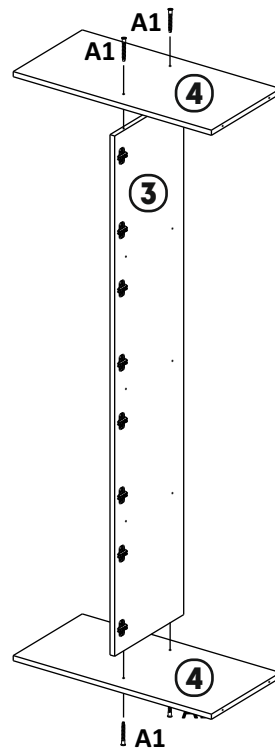
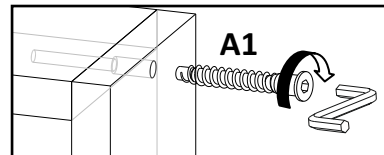
**x4****A1**

**3**

Eurosurb

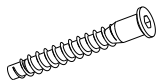

x10

A1

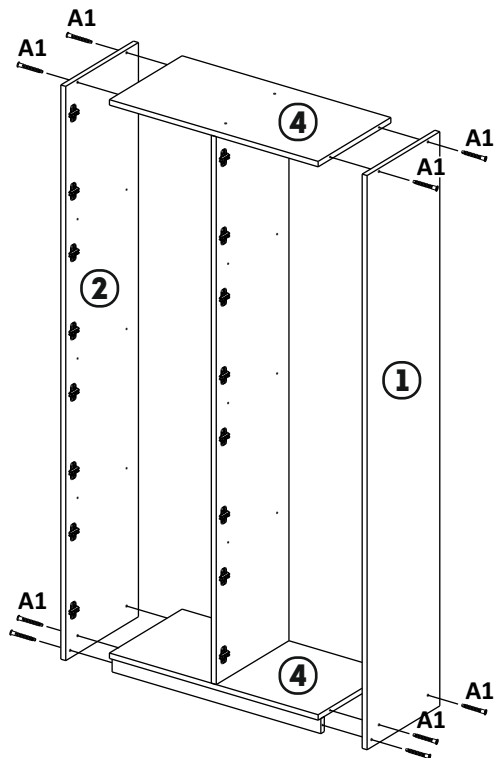
**4**

Alunecator plastic



x4

Q3

Clema fixare

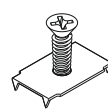

x6

K3

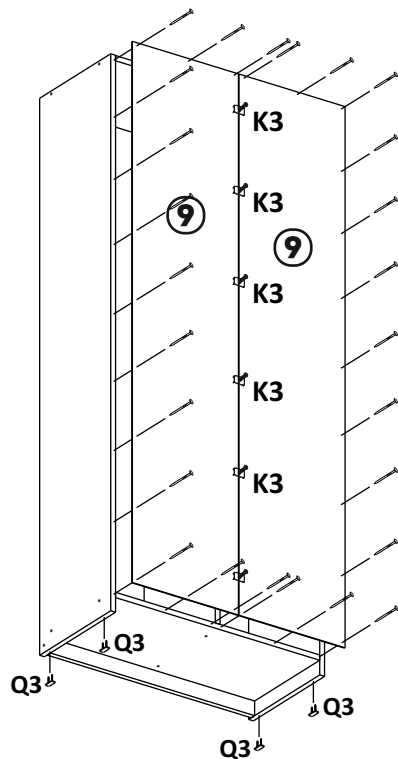

5

Rafix

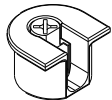

x4

R1

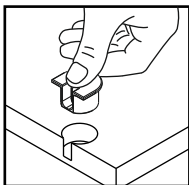

6

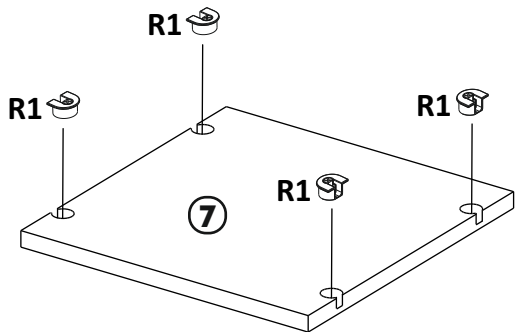
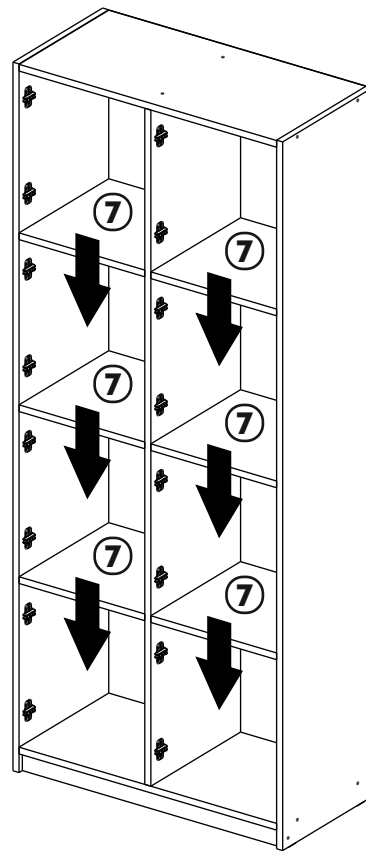
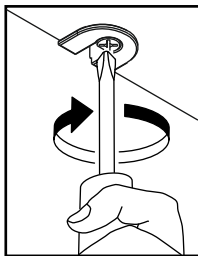
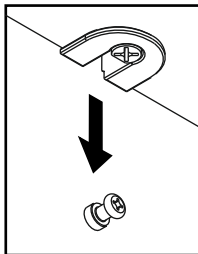

**7**

Încuietoare

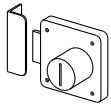

x8

ZM

Balama aplicata

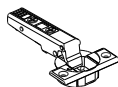

x8

P5

Balama semiaplicate

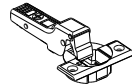

x8

P7

Maner



x8

RP4

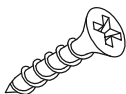
Surub  
3,5x16

x48

W1

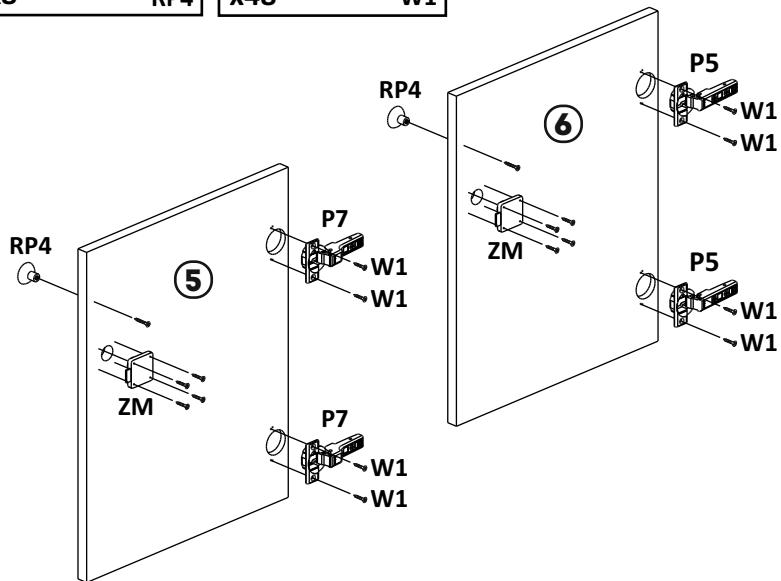
**8**